



Panasonic SIP Phone TGP600, HDV100/130/230/330/430
XML Application Developer's Guide

Revision 2.52

Revision No.	Date	Page	Comments of revision
1.00	16 July, 2015	-	First Release
2.00	14 Sep, 2015	-	Add HDV330/430 models
2.10	08 Dec, 2015	-	Modify some contents for Enhanced feature on December/2015
2.20	18 May, 2016	-	Modify some contents for Enhanced feature on May/2016
2.30	16 Sep 2016		Modify some contents for Enhanced feature on Aug/2016
2.40	2 Nov 2016		Modify some contents for Enhanced feature on Oct/2016
2.50	6 Dec 2016		Modify some contents for Enhanced feature on Dec/2016
2.52	17 May 2017		Delete error code of GetConfig.(Mistype)

[CONTENTS]

1. INTRODUCTION	2
2. OVERVIEW.....	3
2.1. A GENERAL SYSTEM DIAGRAM (NETWORK PHONEBOOK)	3
2.1.1. Easy operation of SIP Server Call Control (e.g. DND/CFWD).....	3
2.1.2. Network Phonebook system example.....	3
2.2. BASIC OPERATION	4
2.2. XML DATA ACCESS FLOW	5
2.3. AVAILABLE MEDIA FORMAT	5
2.4. DISPLAYING PRIORITY	5
2.5. DISPLAY AREA.....	6
3. HTTP SERVER INTERFACE.....	7
3.1. GET XML DATA	7
3.1.1. Structure of HTTP Server	7
3.1.2. HTTP POST/GET Request/Response from the phone to HTTP Server.	8
3.2. PUSH XML DATA	10
3.2.2. Push Event Process	11
3.3. HTTP SEQUENCE EXAMPLE	12
3.3.1. GET XML method.....	12
3.3.2. Push method	12
3.3.3. GET PhoneBook method.....	13
4. PHONE CONFIGURATION AND OPERATION.....	14
4.1. WEB USER INTERFACE SETTING LIST – CONFIGURATION PARAMETER	14
4.2. COMMON CONFIGURATION AND OPERATION	15
4.2.1. Configuration Parameter	15
4.2.2. Remarks of Softkey and FFkey Operation (*1).....	15
4.3. INITIATION METHODS OF XML APPLICATION (*1).....	16
4.3.1. Acquiring XML data corresponding to the Phone Status - Configuration	16
4.3.1.1. Configuration Parameter	16
4.3.2. Network Phone Book Configuration and operation	17
4.3.2.1. Configuration Parameter	17
4.3.2.2 Configuration Parameter (other than LDAP server)	18
4.3.2.3. Network Phonebook operations.....	19
4.3.3. Application Menu Configuration and operation.....	22
4.3.3.1. Configuration Parameter	22
4.3.3.2. Application Menu operations.....	22
4.3.4. Call Log Menu Configuration and operation.....	22
4.3.4.1. Configuration Parameter	22
4.3.4.2. Call Log key operations	22
4.3.5. Initiation Key Configuration and operation	24
4.3.5.1. Configuration Parameter	24
4.3.5.2. Initiation key operations.....	24
4.3.6. Redial key Configuration and operation	26
4.3.6.1. Configuration Parameter.....	26
4.3.6.2. Redial key operations	26
4.3.7. Cursor skip Configuration and operation	26
4.3.7.1. Configuration Parameter.....	26
4.3.7.2. Cursor skip operation	26

5. XML STRUCTURE	27
5.1. XML DOCUMENT	27
5.1.1. XML Schema of the phone	27
5.1.2. Name Space of XML Document.....	28
5.1.3. Character reference	28
5.1.3.1. Predefined Entities in XML	28
5.1.3.2. Numeric Character Reference	28
5.1.4. XML Object Outline	29
5.2. XML OBJECT DEFINITION.....	30
5.2.1. ppxml	31
5.2.2. Screen.....	32
5.2.3. Components.....	33
5.2.4. Label	34
5.2.5. PictureBox.....	36
5.2.6. TextBox	37
5.2.7. Menu	40
5.2.8. PhoneBook.....	44
5.2.9. Events	45
5.2.10. SoftKeys.....	49
5.2.11. FFKeys.....	50
5.2.12. PageKeys(*1)	51
5.2.13. SetVariables	52
5.2.14. Timer	54
5.2.15. Execute	55
5.2.16. Trigger.....	56
5.2.17. Redialkey	57
6. APPENDIX.....	59
6.1. ERROR CODE REFERENCE	59
6.2. EDITING XML CONTENTS ON THE PC	63

ATTENTION

- This document is copyrighted by Panasonic Corporation or its licensor, and is protected by the copyright laws and international treaty provisions, and all other applicable laws.
- All contents of this document are subject to change without notice.
- THIS DOCUMENT IS PROVIDED "AS IS" WITHOUT ANY WARRANTY. Panasonic Corporation AND ITS AFFILIATE COMPANIES ("PANASONIC") DOES NOT MAKE OR PASS ON TO YOU OR OTHER THIRD PARTY, ANY WARRANTY OR REPRESENTATION INCLUDING, BUT NOT LIMITED TO, THE IMPLIED WARRANTIES OF MERCHANTABILITY AND FITNESS FOR A PARTICULAR PURPOSE. WITHOUT LIMITING THE GENERALITY OF THE FOREGOING, PANASONIC DOES NOT WARRANT THAT THIS DOCUMENT WILL BE ERROR-FREE OR THAT IT WILL MEET YOUR REQUIREMENTS. PANASONIC SHALL NOT BE LIABLE FOR ANY DAMAGE SUFFERED BY YOU OR OTHER THIRD PARTY INCLUDING, BUT NOT LIMITED TO, CONSEQUENTIAL, INCIDENTAL, SPECIAL OR PUNITIVE DAMAGES, EVEN IF PANASONIC HAS BEEN ADVISED OF THE POSSIBILITY OF SUCH DAMAGES.

1. Introduction

This document has described the technical information and specification for the XML application development of the TGP600, HDV100/130/230/330/430 (Represents as TGP/HDV).

The corresponding Administrator Guide Document Version is from 2016 and depends on each model.

It is able to acquire the latest firmware and the related documents from the following URL.

`https://panasonic.net/cns/pcc/support/sipphone/index.html`

2. Overview

2.1. A general System Diagram (Network Phonebook)

Various types of applications such as following examples can be developed by using XML API.

2.1.1. Easy operation of SIP Server Call Control (e.g. DND/CFWD)

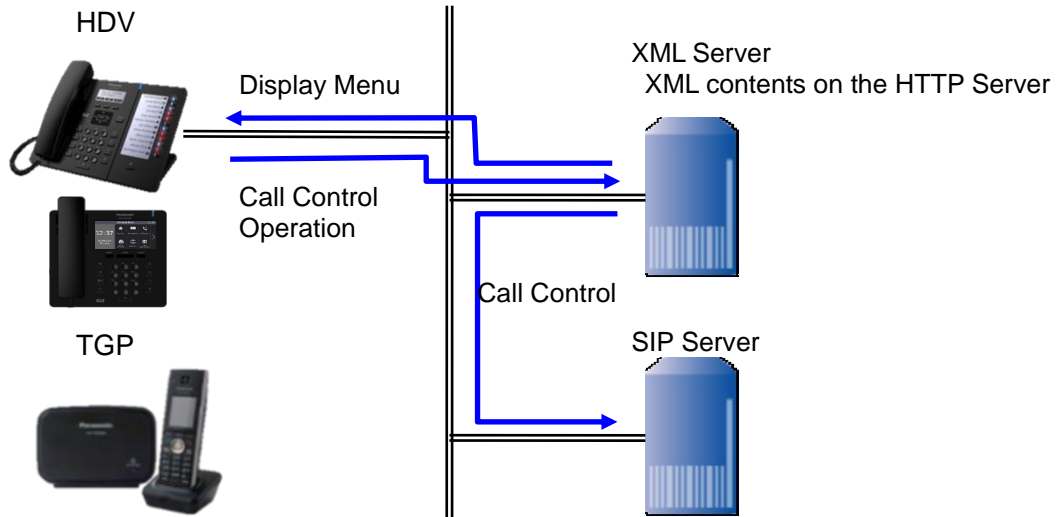

2.1.2. Network Phonebook system example

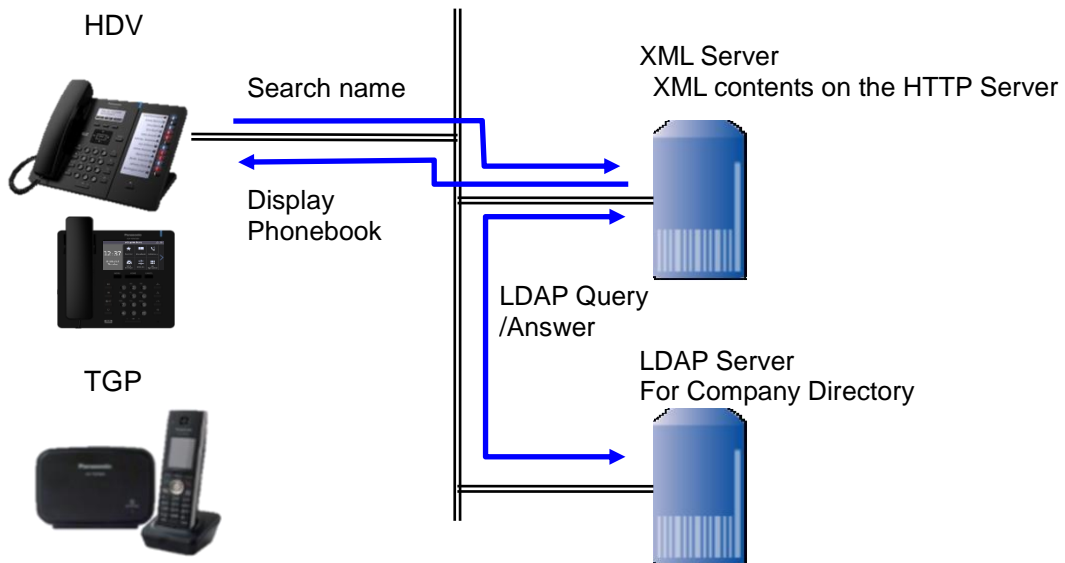

2.2. Basic Operation

The phone translates XML data and generates GUI.

- 1) Parses XML data by using XML parser and analyze the meaning.
- 2) Creates Window for screen.
- 3) Prepare components.
 - Attach event handler and action function.
 - Create component image.
- 4) Place components on Window.
- 5) Show Window.

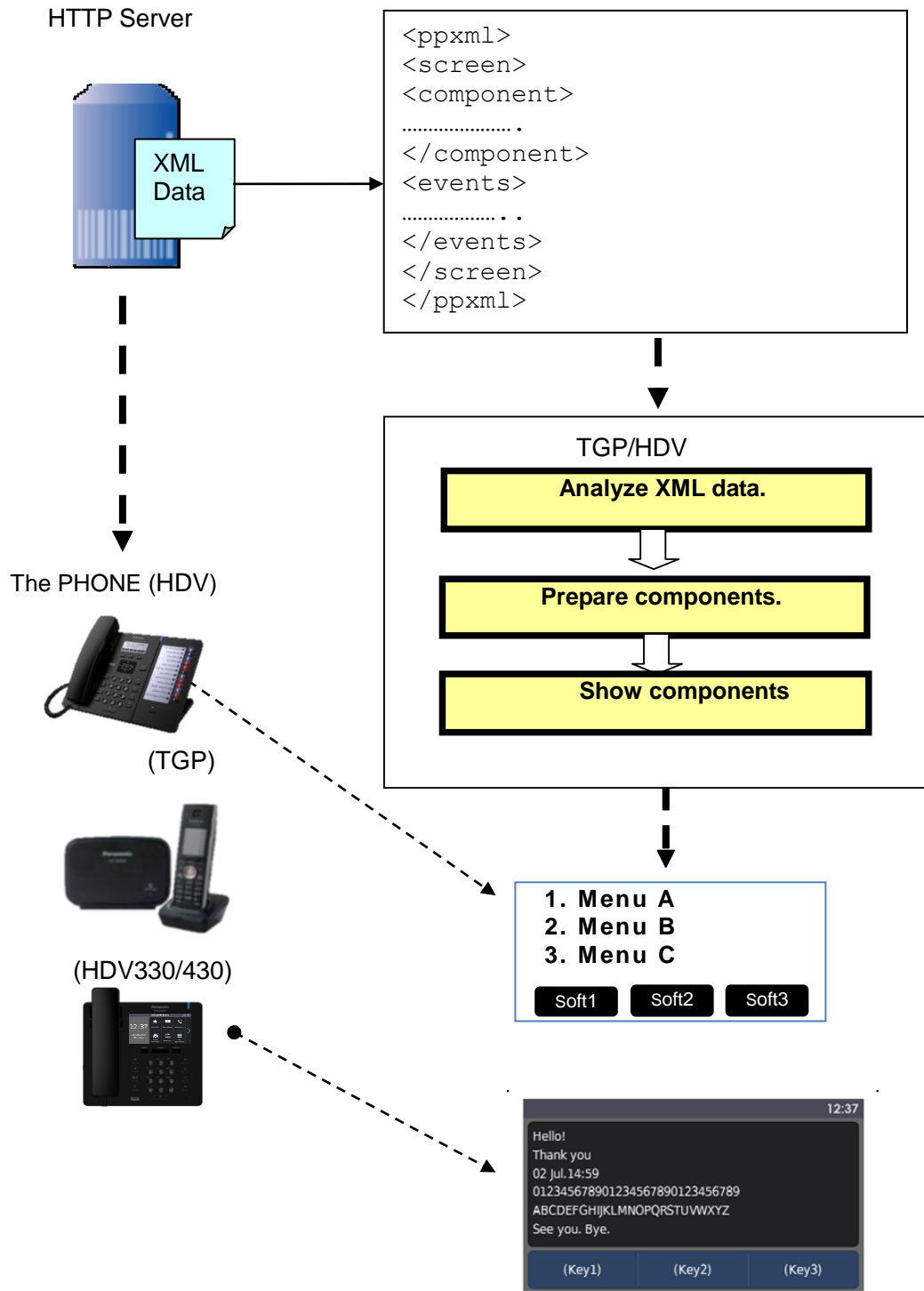

2.2. XML Data Access Flow

There are two methods to access XML Data.

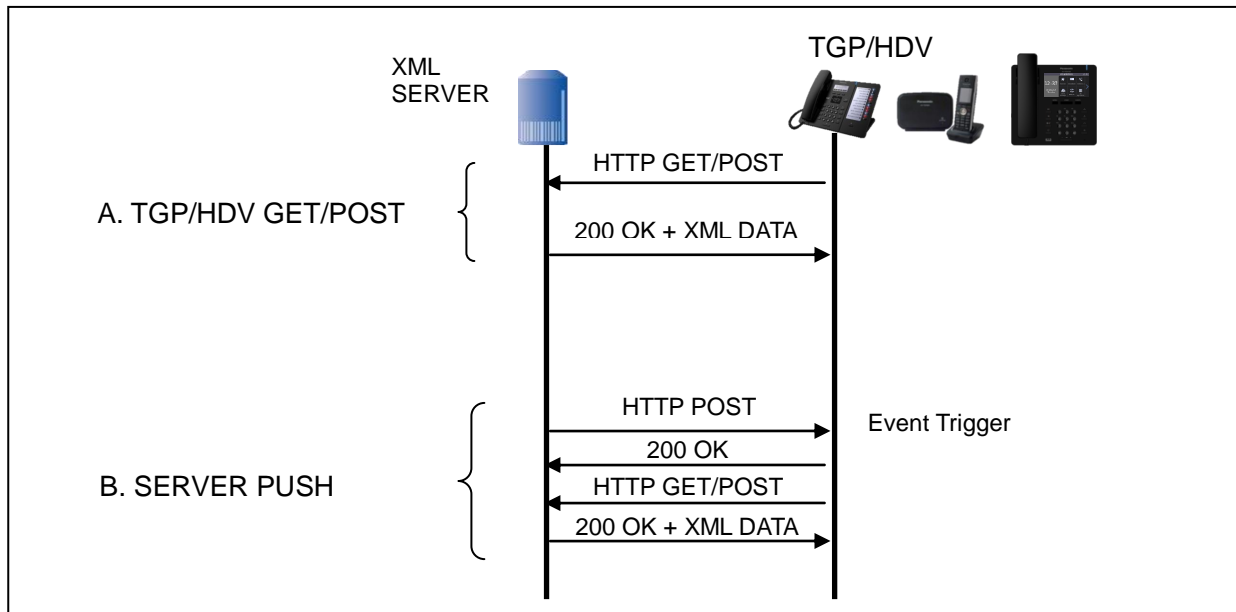

2.3. Available Media Format

The following are available media format which can be supported in the phone. It is recommended to adjust the media quality/size suitably beforehand.

Media	Type	Format	Total Size Max.	Model	Remarks
Picture	BMP	4bit grayscale (The color palette is not supported.)	132 x 64pixels	HDV130/230	Picture is displayed with BW. (Black&White)
Picture	BMP	8 / 16 / 24bit	480 x 245pixels	HDV330/430	Picture is displayed as a 256 Color/High Color/True Color
Text	TXT	UTF-8 plain text	128bytes	(Depends on Models)	Character references are not supported except specific cords .

2.4. Displaying priority

The displayed objects are always overwritten in postscript information.

2.5. Display Area

HDV100/130/230 (4 line)

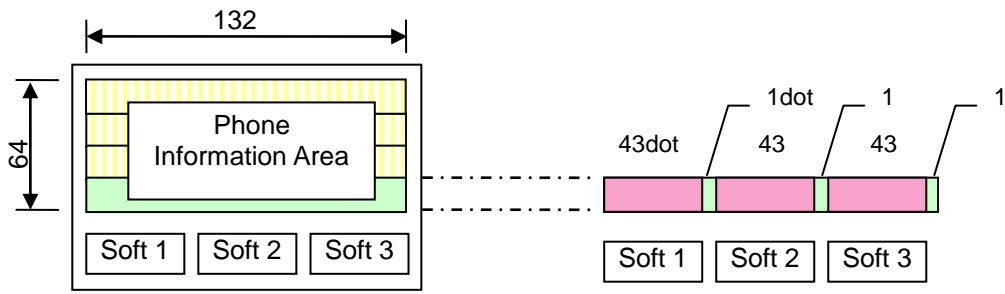

TGP600 (6 line)

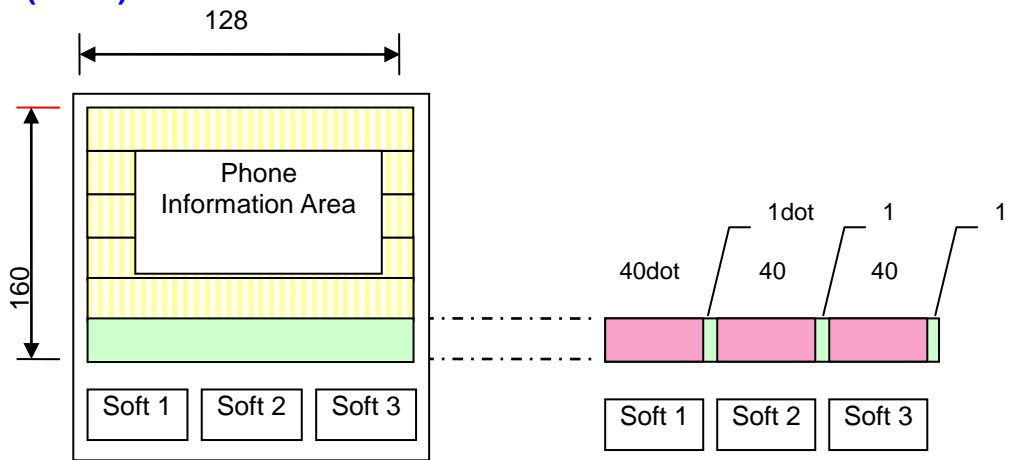

HDV330/430 (6 line)

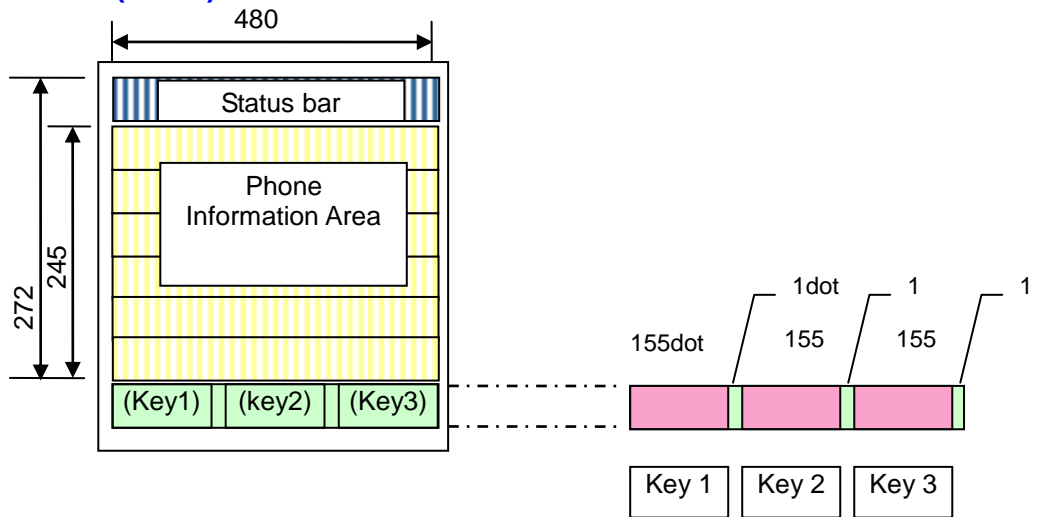

3. HTTP Server Interface

3.1. Get XML Data

3.1.1. Structure of HTTP Server

HTTP Server is installed in followings:

- 1) PC Server
- 2) Appliance Server

HTTP Server usually manages following directory.

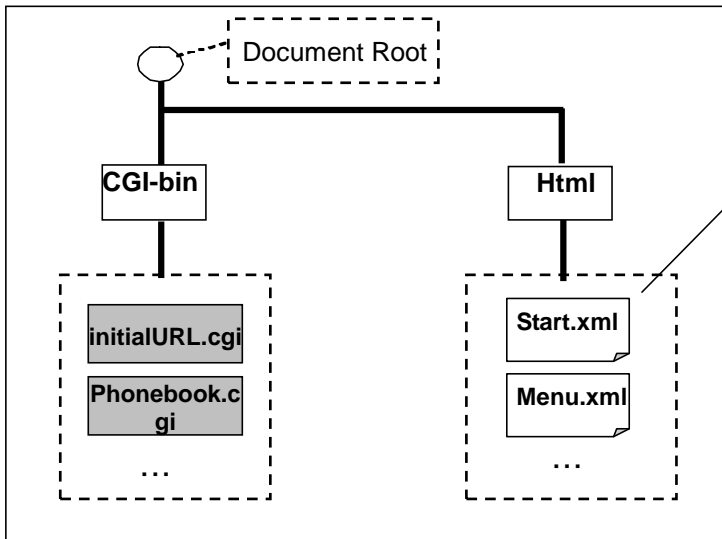

CGI for the phone usually processes along following steps.

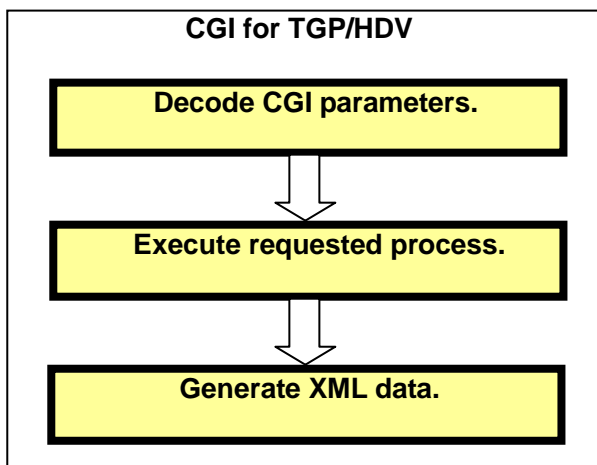

3.1.2. HTTP POST/GET Request/Response from the phone to HTTP Server.

[HTTP POST/GET Request]

The phone sends HTTP POST/GET request to HTTP Server as the result of "SendRequest" Action. The format of HTTP POST/GET request is same as ordinary HTTP POST/GET request.

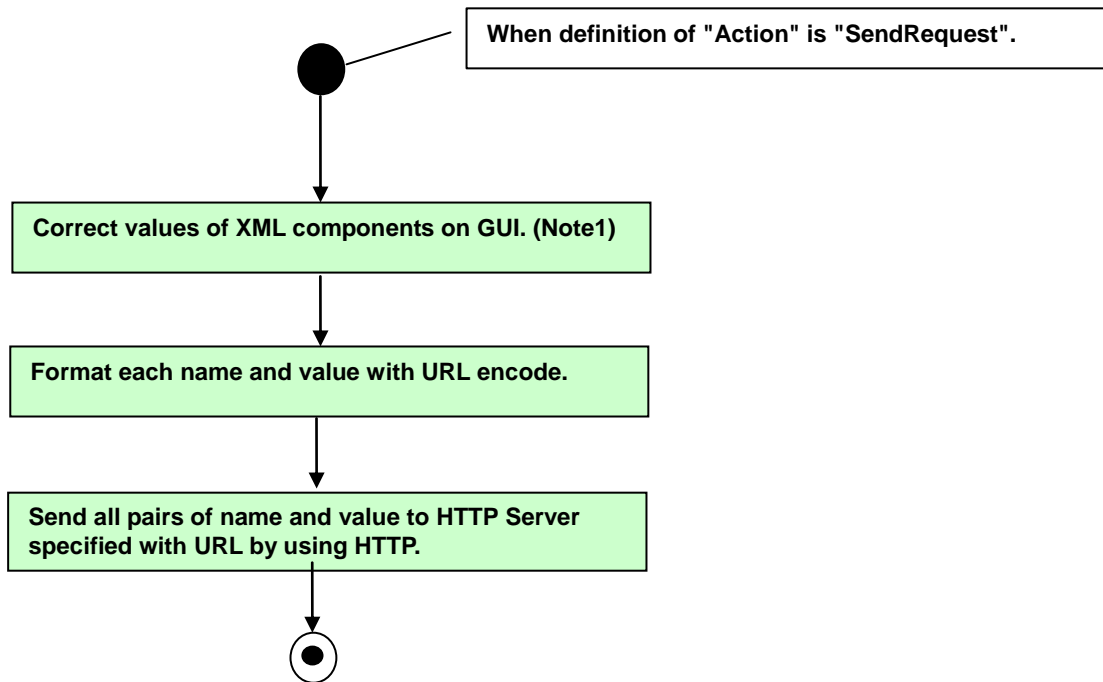

<Note1>

There are some values reserved values by the phone.

These values are automatically replaced by the phone and sent to HTTP Server.

[HTTP POST/GET Response]

TGP/HDV receives HTTP response including XML data from HTTP Server.

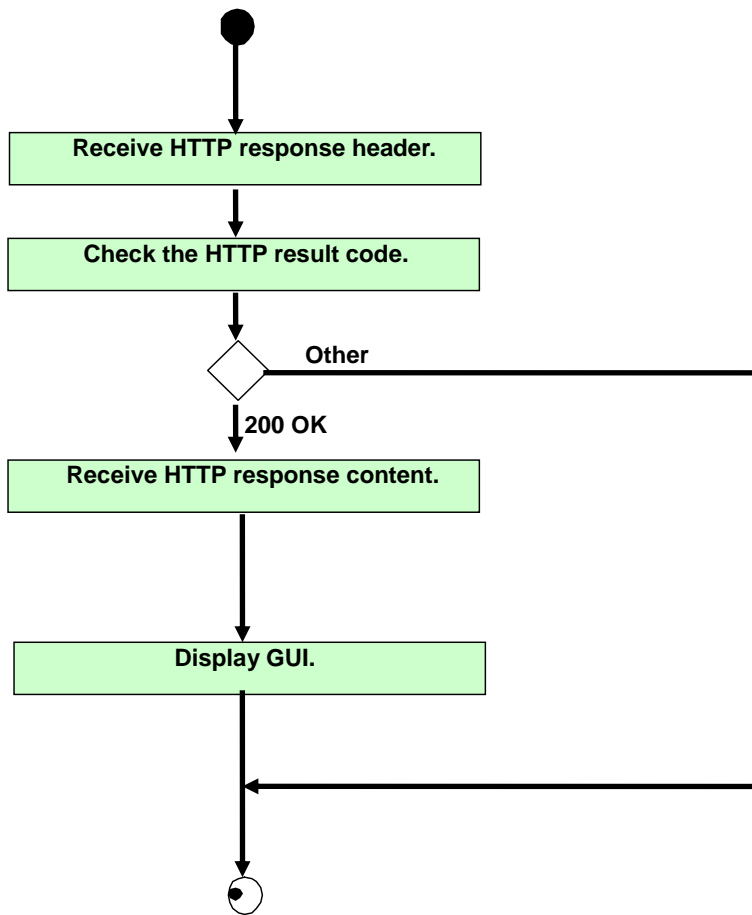

3.2. Push XML Data

3.2.1. Push Mechanism

Push may be kicked by PC Client which operator uses.

Push is achieved with 2 steps.

First step is to send trigger.

Second step is to get XML data. (This is same as the description of "Get XML data".)

HTTP Server sends a Link XML data as Trigger, which describes the behavior of TGP/HDV, to "Push Port" by using HTTP POST.

When TGP/HDV catches the Link XML data, TGP/HDV executes Push Event process.

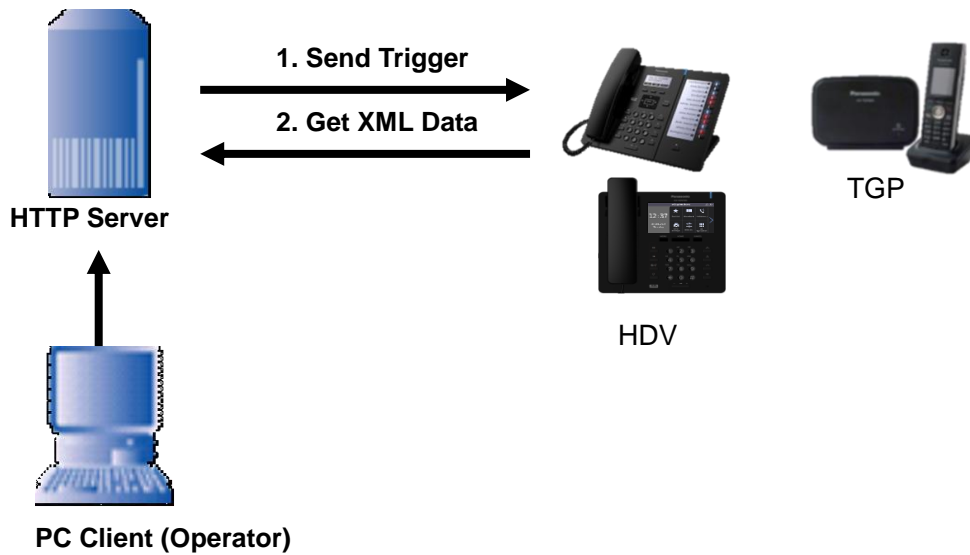

3.2.2. Push Event Process

When considering from the phone side, this process is separated to 2 phases. (Processing Trigger and Processing Service Content.)

This phase processes a trigger.
A TCP/IP connection is kept during following flow.

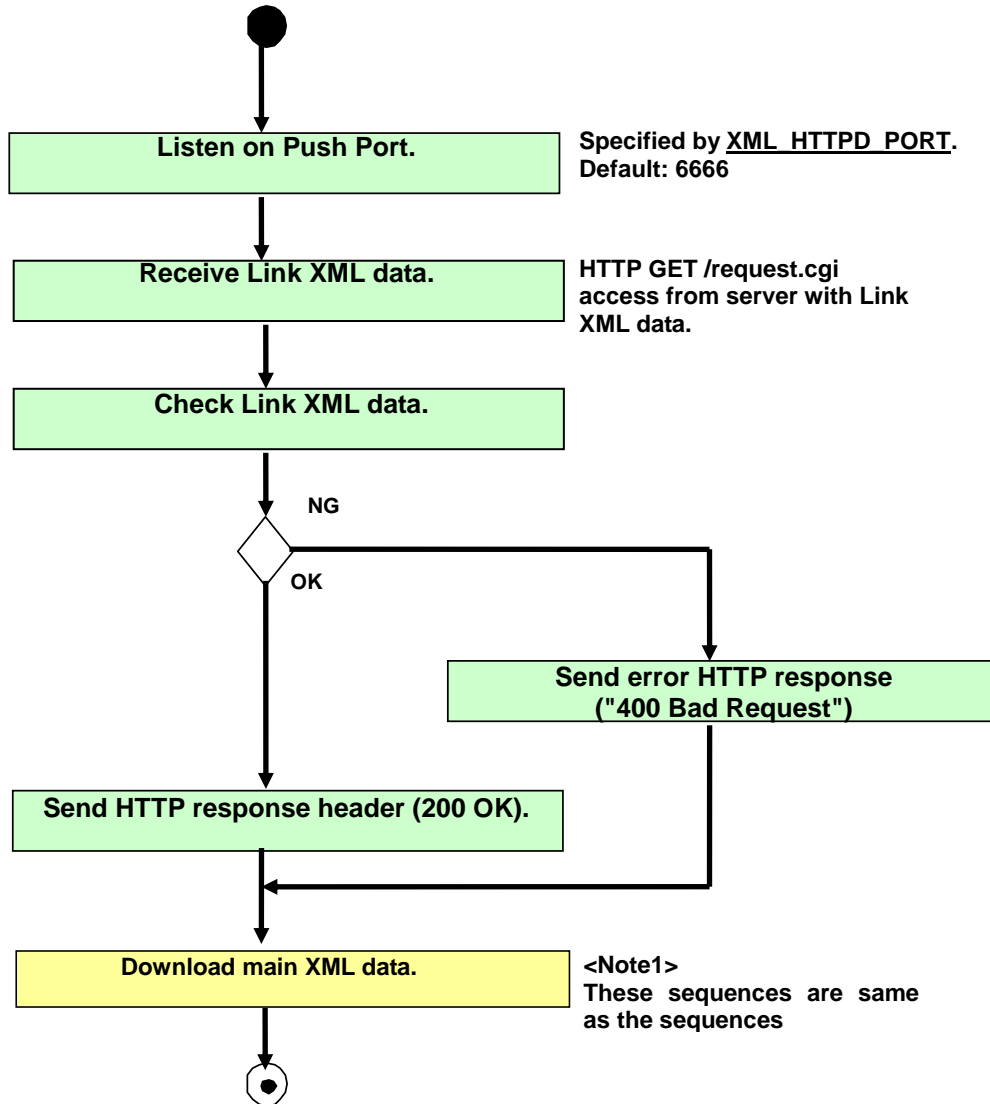

3.3. HTTP Sequence Example

The followings are some HTTP sequence example for reference. *For example: KX-HDV330

3.3.1. GET XML method

```
GET /hdv330/pana.xml?tb=ABC4567890ABC4567890ABCD HTTP/1.0
User-Agent: Panasonic_KX-HDV330/01.066 (0080f0xxxxxx)
Host: 192.168.0.100:80
```

Get XML data from the phone to the server.

```
HTTP/1.1 200 OK
Server: Microsoft-IIS/5.1
X-Powered-By: ASP.NET
Date: Fri, 16 Dec 2011 01:46:29 GMT
Content-Type: text/xml
Accept-Ranges: bytes
Last-Modified: Thu, 01 Dec 2011 07:21:33 GMT
ETag: "902242daf9afcc1:1023"
Content-Length: 433
```

200 OK if accepted.

```
<?xml version="1.0" encoding="utf-8"?>
<ppxml xmlns="http://panasonic/sip_screen"
xmlns:xsi="http://www.w3.org/2001/XMLSchema-instance"
xsi:schemaLocation="http://panasonic/sip_screen sip_screen.xsd">
  <Screen name="Screen" version="3.0">
    <Components>
      <PictureBox name="PictureBox1" left="0" top="27" width="120" height="55"
source="http://192.168.0.100/hdv330/pana4.bmp" />
    </Components>
  </Screen>
</ppxml>
```

Acquired XML data

Note. <Except for HDV330/430>

```
<PictureBox name="PictureBox1" left="0" top="0" width="120" height="55"
source="http://192.168.0.100/hdv330/pana4.bmp" />
```

3.3.2. Push method

Fixed file name for push request.

```
GET /Request.cgi HTTP/1.1
HOST: 192.168.0.115
Content-Type: text/xml
Content-Length: 305
```

Access to the port 6666 of the phone from server.

```
<?xml version="1.0" encoding="utf-8"?>
<ppxml xmlns="http://panasonic/sip_menu"
xmlns:xsi="http://www.w3.org/2001/XMLSchema-instance"
xsi:schemaLocation="http://panasonic/sip_menu sip_menu.xsd">
  <Trigger version="3.0">
    <Source>http://192.168.0.111/hdv330/Page1.xml</Source>
  </Trigger>
</ppxml>
```

Link XML data

```
HTTP/1.1 200 OK
Connection: Keep-Alive
Content-type:text/html; charset=UTF-8
Status:200
Content-length: 0
```

200 OK if accepted.

```
GET /HDV330/Page1.xml HTTP/1.0
User-Agent: Panasonic_KX-HDV330/01.023 (0080f0xxxxxx)
Host: 192.168.0.111:80
```

Get main XML data from the phone to the server.

```
HTTP/1.1 200 OK
```

Server: Microsoft-IIS/5.1
X-Powered-By: ASP.NET
Date: Thu, 13 Oct 2011 01:31:59 GMT
Content-Type: text/xml
Accept-Ranges: bytes
Last-Modified: Thu, 13 Oct 2011 01:23:31 GMT
ETag: "50c144b84689cc1:fc1"
Content-Length: 359

```
<?xml version="1.0" encoding="utf-8"?>  
<ppxml xmlns="http://panasonic/sip_screen"  
xmlns:xsi="http://www.w3.org/2001/XMLSchema-instance"  
xsi:schemaLocation="http://panasonic/sip_screen sip_screen.xsd">  
  <Screen version="3.0">  
    <Components>  
      <Label area="DesiLess" name="Label1" line="3" text="Page1 Show!" />  
    </Components>  
  </Screen>  
</ppxml>
```

Acquired XML data

3.3.3. GET PhoneBook method

GET
/DirectoryAccessForLDAP/get_directory.aspx?max_rec=20&base=dc%3Dmy-domain%2Cdc%3Dcom&name=T&userid=cn%3Dmanager%2Cdc%3Dmy-domain%2Cdc%3Dcom&userpass=secret
HTTP/1.0
User-Agent: Panasonic_KX-HDV330/01.070 (0080f0xxxxxx)
Host: 192.168.70.36:80

Get XML data from the phone to the phonebook server.
e.g.) searching "T"

HTTP/1.1 200 OK
Server: Microsoft-IIS/5.1
Date: Wed, 21 Dec 2011 07:52:46 GMT
X-Powered-By: ASP.NET
X-AspNet-Version: 2.0.50727
Cache-Control: private
Content-Type: text/xml; charset=utf-8
Content-Length: 1742

200 OK if accepted.

```
<?xml version="1.0" encoding="utf-8"?><ppxml xmlns="http://panasonic/sip_phone"  
xmlns:xsi="http://www.w3.org/2001/XMLSchema-instance"  
xsi:schemaLocation="http://panasonic/sip_phone_directory  
sip_phone_phonebook.xsd"><Screen version="2.0"><PhoneBook version="2.0"><Personnel  
id="1"><Name>Test User01</Name><Ruby>Test01</Ruby><PhoneNums><PhoneNum  
type="ext">6789</PhoneNum><PhoneNum type="company">382719</PhoneNum><PhoneNum  
type="mobile">928378</PhoneNum><PhoneNum type="home">6789</PhoneNum><PhoneNum  
type="etc">382719</PhoneNum></PhoneNums></Personnel><Personnel id="2"><Name>Test  
User02</Name><Ruby>Test02</Ruby><PhoneNums><PhoneNum  
type="ext">6058</PhoneNum><PhoneNum type="company">777058</PhoneNum><PhoneNum  
type="mobile">888012</PhoneNum><PhoneNum type="home">6058</PhoneNum><PhoneNum  
type="etc">777058</PhoneNum></PhoneNums></Personnel><Personnel id="3"><Name>Test  
User03</Name><Ruby>Test03</Ruby><PhoneNums><PhoneNum  
type="ext">6001</PhoneNum><PhoneNum type="company">777001</PhoneNum><PhoneNum  
type="mobile">888001</PhoneNum><PhoneNum type="home">6001</PhoneNum><PhoneNum  
type="etc">777001</PhoneNum></PhoneNums></Personnel><Personnel id="4"><Name>Test  
user04</Name><Ruby>Test04</Ruby><PhoneNums><PhoneNum  
type="ext">6053</PhoneNum><PhoneNum type="company">777053</PhoneNum><PhoneNum  
type="mobile">888053</PhoneNum><PhoneNum type="home">6053</PhoneNum><PhoneNum  
type="etc">777053</PhoneNum></PhoneNums></Personnel><Personnel id="5"><Name>Test  
user05</Name><Ruby>Test05</Ruby><PhoneNums><PhoneNum  
type="ext">6002</PhoneNum><PhoneNum type="company">777002</PhoneNum><PhoneNum  
type="mobile">888002</PhoneNum><PhoneNum type="home">6002</PhoneNum><PhoneNum  
type="etc">777002</PhoneNum></PhoneNums></Personnel></PhoneBook></Screen></ppxml  
>
```

Acquired XML data

4. Phone Configuration and Operation

4.1. Web User Interface Setting List – Configuration Parameter

Network * For example: KX-HDV230

Menu Item	Section Title	Setting	Configuration Parameter
XML Application Settings	XML Application	Enable XMLAPP	XMLAPP_ENABLE
		User ID	XMLAPP_USERID
		Password	XMLAPP_USERPASS
		Local XML Port	XML_HTTPD_PORT
		Bootup URL (*2)	XMLAPP_START_URL
		Initial URL (*2)	XMLAPP_INITIAL_URL
		Incoming Call URL (*2)	XMLAPP_INCOMING_URL
		Talking URL (*2)	XMLAPP_TALKING_URL
		Making Call URL (*2)	XMLAPP_MAKECALL_URL
		Call Log URL (*2)	XMLAPP_CALLLOG_URL
		Idling URL (*2)	XMLAPP_IDLING_URL
		Enable FF Key (*2)	XMLAPP_FFKEY_ENABLE
	Shortcut Key Settings (*1)	Soft Key A(Left)	XML_INITIATE_KEY_SOFT1
		Soft Key B(Center)	XML_INITIATE_KEY_SOFT2
		Soft Key C(Right)	XML_INITIATE_KEY_SOFT3
	XML Phonebook	LDAP URL	XMLAPP_LDAP_URL
		User ID	XMLAPP_LDAP_USERID
		Password	XMLAPP_LDAP_USERPASS
		Max Hits	XMLAPP_LDAP_MAXRECORD

Note. (*1) HDV330/430 doesn't support Shortcut Key Settings, since there are no Initiation Key.

(*2) Supported only HDV130/230/330/430.

The screenshot displays the Panasonic KX-HDV230 web interface. The top navigation bar includes 'Status', 'Network', 'System', 'VoIP', 'Telephone', and 'Maintenance'. The 'Network' section is expanded, showing a sidebar with various settings categories. The 'XML Application Settings' page is active, displaying a list of configuration parameters for XML Application and Shortcut Key Settings. The 'XML Application' section includes options for enabling XMLAPP, setting User ID, Password, Local XML Port (6666), and various URLs (Bootup, Initial, Incoming Call, Talking, Making Call, Call Log, Idling). The 'Shortcut Key Settings' section includes options for enabling Soft Key A (Left), Soft Key B (Center), and Soft Key C (Right). Red boxes highlight the 'XML Application Settings' and 'Shortcut Key Settings' sections in the screenshot.

4.2. Common Configuration and Operation

It is necessary to set this configuration parameter for activating XML application feature.

4.2.1. Configuration Parameter

Configuration parameters are as follows.

Configuration Parameter	Description	Format	Value Range	Default Value
XMLAPP_ENABLE	Set "Y" for activating XML application feature.	Boolean	Y/N	N
XMLAPP_USERID	Specify user ID for XML server authentication	String	Max. 128 characters	Empty String
XMLAPP_USERPASS	Specify the Password for XML server authentication	String	Max. 128 characters	Empty String
XML_HTTPD_PORT	Specify listen port number for receiving XML push event from XML server.	Integer	1 to 65535	6666
XML_ERROR_INFORMATION	Set "N" in order to inhibit displaying error information on the phone's LCD.	Boolean	Y/N	Y

If it is necessary to access secure to the network phonebook server, it is able to use HTTPS protocol instead of HTTP.

For that, it is necessary to compose the following parameters in the addition. (C.f. Admin Guide)

Configuration Parameter	Description	Format	Value Range	Default Value
HTTP_SSL_VERIFY	Specifies whether to enable the verification of the root certificate. - 0 (No verification) - 1 (Simple verification) - 2 (Precise verification)	Integer	0~2	0
CFG_ROOT_CERTIFICATE_PATH	Specifies the URI of the root certificate.	String	Max.384 characters	Empty String

4.2.2. Remarks of Softkey and FFkey Operation (*1)

When XML contents are displayed, Softkeys and FFkeys are controlled according to its XML definition.

It means default Softkey and FFkey for phone use cannot be used in the XML contents.

It is able to exit from XML contents by using following methods.

- Press **[Cancel]** button.
- Off hook the handset
- **[SP-PHONE]** On.

Note. (*1) HDV330/430 are supported only FFKey Operation.TGP600 and HDV100 are not supported.

Configuration Parameter	Description	Format	Value Range	Default Value
XML_SOFT_KEY_NAME _x	_x =1-3 Specifies the name of Soft Key A/B/C assigned XML application.	String	Max.16 characters	Empty String

4.3. Initiation methods of XML application (*1)

The phone has six types of methods to access XML contents as follows.

- Phone Status (4.3.1)
- Phonebook menu (4.3.2)
- Application menu (4.3.3)
- Call log key (4.3.4)
- Initiation key (4.3.5)
- Redial key(4.3.6)

Please refer to each section for more detail.

Note. (*1) Supported only HDV130/230/330/430.

4.3.1. Acquiring XML data corresponding to the Phone Status - Configuration

It is able to acquire specified XML data linked to the status of the phone.

For example, company logo bitmap is display when the phone goes idle status.

Operations depend on the each XML data.

4.3.1.1. Configuration Parameter

Configuration parameters are as follows.

Configuration Parameter	Description	Format	Value Range	Default Value
XMLAPP_START_URL	Specify the XML URL to acquire when the phone starts up. It is useful for displaying startup logo. This is only once when the phone starts.	String	Max. 256 characters	Empty String
XMLAPP_INITIAL_URL	Specifies the URL that is accessed when the application is started from the unit's menu, to check for XML data.			
XMLAPP_INCOMING_URL	Specify the XML URL to acquire when the phone receives a call.			
XMLAPP_TALKING_URL	Specify the XML URL to acquire when the phone goes talking.			
XMLAPP_MAKECALL_URL	Specify the XML URL to acquire when the phone goes off-hook.			
XMLAPP_CALLLOG_URL	Specifies the URL that is accessed when the call log is accessed, to check for XML data.			
XMLAPP_IDLING_URL	Specify the XML URL to acquire when the phone is idle state. It is useful for displaying company logo in the idle state.			
XMLAPP_FFKEY_ENABLE	Specifies whether to use the XML application or operate normal telephone when the corresponding button is pressed. (FF Key and Page Key) Y: XML Mode N: Normal Telephone Mode	Boolean	Y/N	N
XMLAPP_STATUSBAR_ENABLE (*1)	Selects whether to enable or disable "Icon, Text, Clock on the Status Bar XML application feature." Y: Enable Display "Icon, Text, Clock" on Status Bar N: Disable	Boolean	Y/N	Y

(*1)It is not possible to notify internal variables, such as originating call number, to XML server dynamically.

Note. (*1) Only HDV330/430 supports the "XMLAPP_STATUSBAR_ENABLE"

4.3.2. Network Phone Book Configuration and operation

It is able to use embedded "Network Phone Book "menu by configuring according to this section.

4.3.2.1. Configuration Parameter

Configuration parameters are as follows.

Configuration Parameter	Description	Format	Value Range	Default Value
XMLAPP_LDAP_URL	URL for Phonebook proxy server If the fixed parameters are necessary, you should include CGI parameter in this URL. e.g.) XMLAPP_LDAP_URL="http://192.168.1.10/get_ldap.cgi?model=hdv330&max_rec=20"	String	Max.256 characters	Empty String
XMLAPP_LDAP_USERID ^(*1)	ID for LDAP server connection. This parameter is automatically added to LDAP URL as a CGI parameter.	String	Max. 128 characters	Empty String
XMLAPP_LDAP_USERPASS ^(*1)	Password for LDAP server connection. This parameter is automatically added to LDAP URL as a CGI parameter.	String	Max. 128 characters	Empty String
XMLAPP_LDAP_MAXRECORD	Specifies the maximum number of search results to be returned by the LDAP server	Integer	20 to 500	20

Note. This function is supported by TGP600/HDV100/HDV130/HDV230/HDV330/HDV430.

(*1)

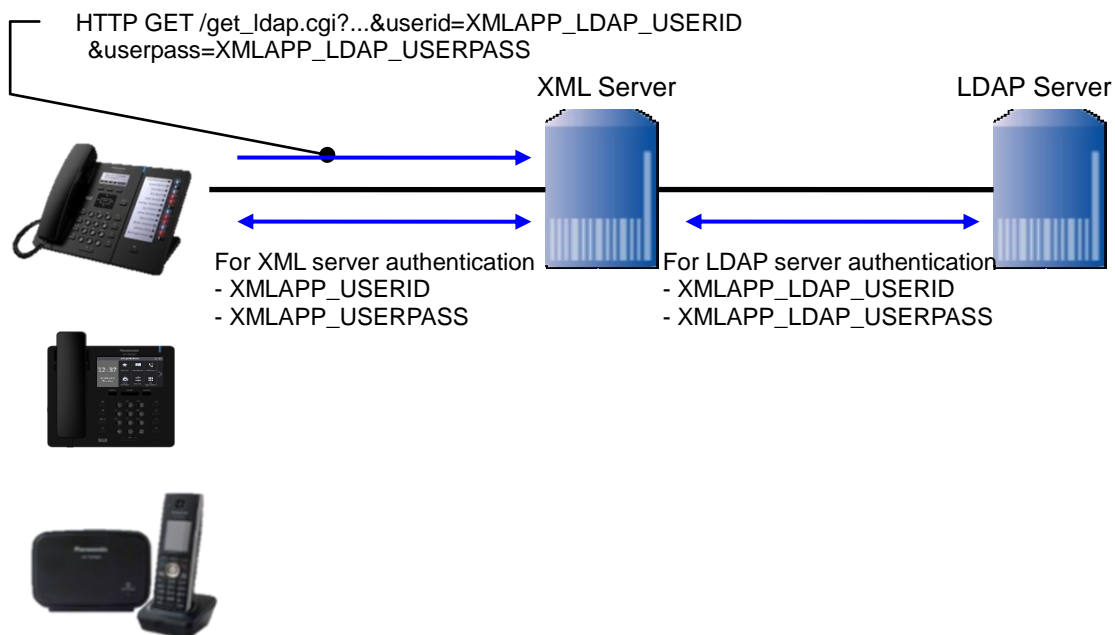

4.3.2.2 Configuration Parameter (other than LDAP server)

Configuration parameters are as follows.

Configuration Parameter	Description	Format	Value Range	Default Value
XML_PHONEBOOK_URL	Specifies the URL for XML Phonebook file that is accessed.	String	Max.256 characters	Empty String
XML_PHONEBOOK_CYCLIC_INTERVAL	Specifies the interval, in minutes, between periodic checks for updates of the XML Phonebook files. When the parameter is set to '0', the timing is the same updating of the configuration files.	Integer	0, 1 to 40320	0

Note. This function is supported by TGP600/HDV130/HDV230/HDV330/HDV430.

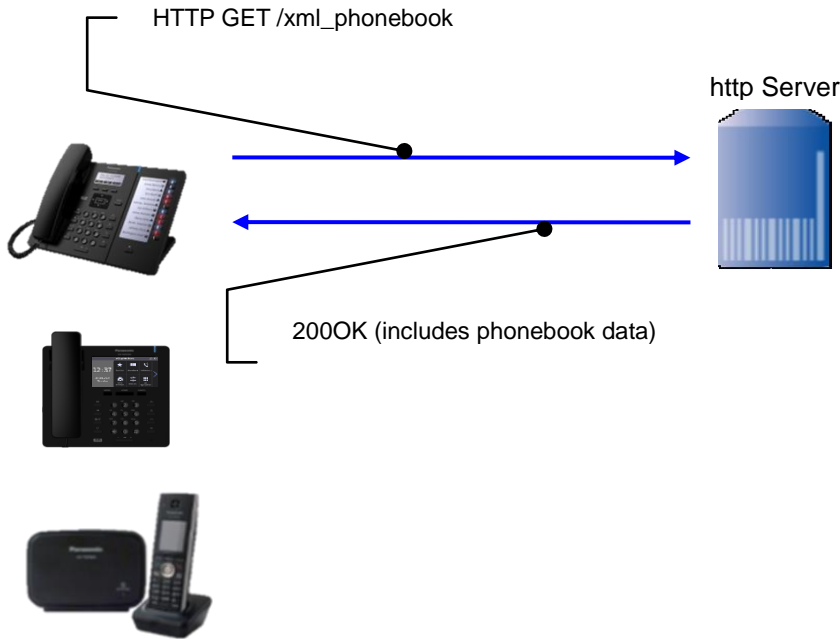

The further information of the XML file format is described on the [5.2.18](#).

4.3.2.3. Network Phonebook operations

<TGP600, HDV100/HDV130/230>

The network phonebook operations are almost same as embedded local phonebook operations by using PhoneBook element. Please refer to the Operating Instructions for detailed operation of phonebook. (It is also possible to construct different user interface originally by using another element.)

If the above parameters are set, the following menu is displayed when the user press  key.

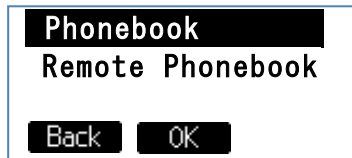

Please select [**Remote Phonebook**] menu, and press  key. Then the phone accesses to the phonebook server with the following URL.

`http://192.168.0.10/get_ldap.cgi?model=hdv230&max_rec=20&name=`

Note) '&name=' part is added by the phone automatically. This name parameter is set for name query. However query parameter is set null in the first access. The front part is same as configuration parameter.

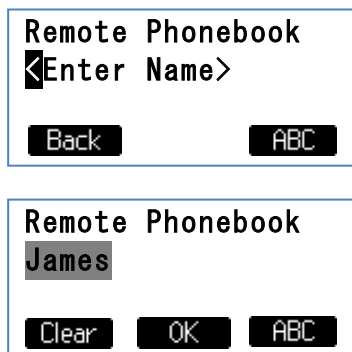

If the query word is entered and pressed  key, the phone access to the phonebook server with the following URL.

`http://192.168.0.10/get_ldap.cgi?model=hdv230&max_rec=20&name=James`

If there are acquiring data, the following screen is displayed.

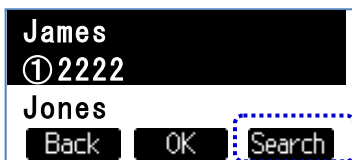

If there are no acquired data, the following screen is displayed.



It is able to display acquired data by using [▲] or [▼] key.

It is able to search that **Search** key is pressed and please enter the search words.

<HDV330/430>

The network phonebook operations are almost same as embedded local phonebook operations by using PhoneBook element. Please refer to the Operating Instructions for detailed operation of phonebook. (It is also possible to construct different user interface originally by using another element.)

If the above parameters are set, the **[Phonebook]** menu is displayed at the Top Menu.

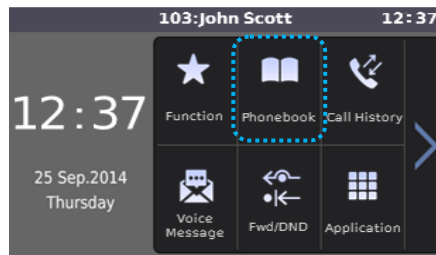

Please select **[Phonebook]** menu, and press  icon.

Then the phone accesses to the phonebook server with the following URL.

```
http://192.168.0.10/get_ldap.cgi?model=hdv330&max_rec=20&name=
```

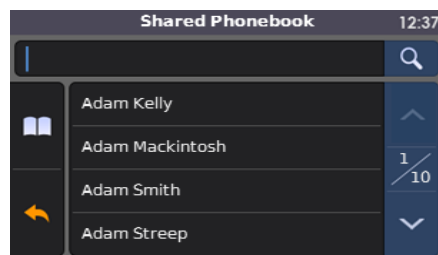

Note) '&name=' part is added by the phone automatically. This name parameter is set for name query. However query parameter is set null in the first access. The front part is same as configuration parameter.

If there are phonebook data in the Network Phonebook, the following screen is displayed.

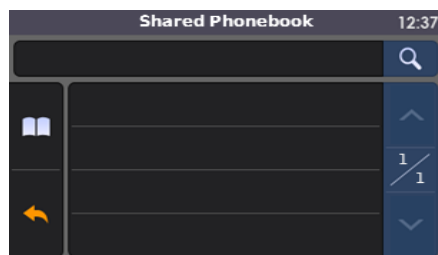

If there are not phonebook data in the Network Phonebook, the following screen is displayed.



If  [Search] icon or  [Edit Box] icon is tapped, the following screen is displayed.

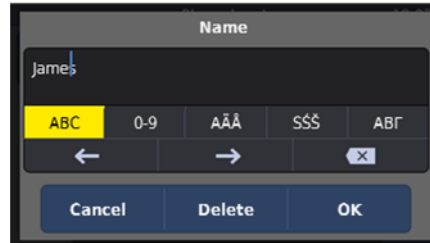
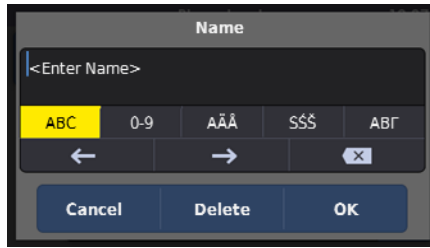

If the query word is entered and tapped  icon, the phone access to the phonebook server with the following URL.

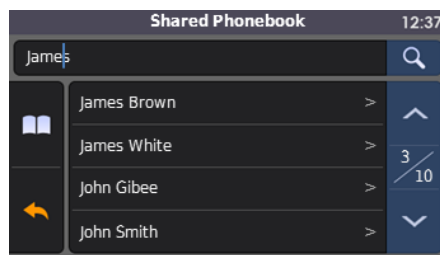

`http://192.168.0.10/get_ldap.cgi?model=hdv330&max_rec=20&name=James`

If there are acquiring data, the following screen is displayed.

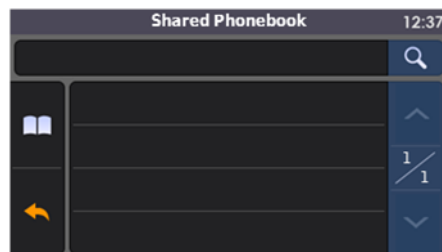

If there are no acquired data, the following screen is displayed.



It is able to display acquired data by using  or  icon.

It is able to search that  [search] icon is pressed and please enter the search words.

4.3.3. Application Menu Configuration and operation

4.3.3.1. Configuration Parameter

Configuration parameters are as follows.

Configuration Parameter	Description	Format	Value Range	Default Value
XMLAPP_INITIAL_URL	Specify the XML URL to acquire when the XML application starts up from [Application] menu. * <HDV330/430> [Application] menu	String	Max. 256 characters	Empty String

4.3.3.2. Application Menu operations

<HDV130/230>

If the configuration parameter, “XMLAPP_INITIAL_URL”, is specified, the **[Application]** menu is displayed at the bottom of setting menu.

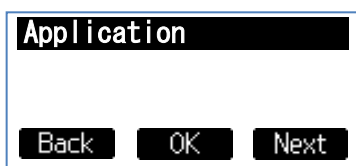

<HDV330/430>

If the configuration parameter, “XMLAPP_INITIAL_URL”, is specified, the **[Application]** menu is displayed at the bottom of Top menu.

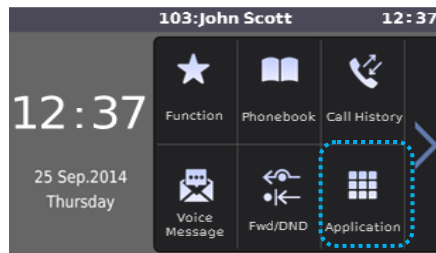

When **[Application]** menu is selected, the phone access to the URL which is specified in the XMLAPP_INITIAL_URL configuration parameter.

After that, it is able to construct various UI by using XML application interface.

4.3.4. Call Log Menu Configuration and operation

4.3.4.1. Configuration Parameter

Configuration parameters are as follows.

Configuration Parameter	Description	Format	Value Range	Default Value
XMLAPP_CALLLOG_URL	Specify the XML URL to acquire when the [Call Log] menu is selected. * <HDV330/430> [Call History] menu	String	Max. 256 characters	Empty String

4.3.4.2. Call Log key operations

<HDV130/230>

If the configuration parameter, “XMLAPP_CALLLOG_URL”, is specified, and when **Call Log** key is pressed, the phone access to the above-mentioned URL.

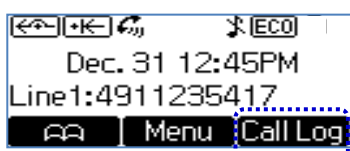

<HDV330/430>

If the configuration parameter, "XMLAPP_CALLLOG_URL", is specified, and when **icon** is pressed, the phone access to the above-mentioned URL.

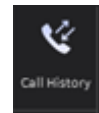

[Call History]

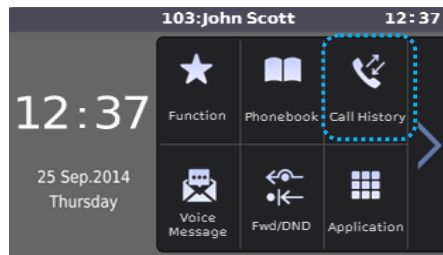

After that, it is able to construct various call log UI by using XML application interface.

4.3.5. Initiation Key Configuration and operation

4.3.5.1. Configuration Parameter

Configuration parameters are as follows.

Model: HDV130

The phone can access to initial URI by press softkey or program(flexible) key.

Configuration Parameter	Description	Format	Value Range	Default Value
XML_INITIATE_KEY_SOFT1	Enables initiation of XML application from Soft Key1. Key information : SOFT1	Boolean	Y/N	N
XML_INITIATE_KEY_SOFT2	Enables initiation of XML application from Soft Key2. Key information : SOFT3	Boolean	Y/N	N
XML_INITIATE_KEY_SOFT3	Enables initiation of XML application from Soft Key3. Key information : SOFT3	Boolean	Y/N	N
FLEX_BUTTON_FACILITY_ACT1	Enables initiation of XML application from Program Key1. Key information : PK1	String	*1	Null
FLEX_BUTTON_FACILITY_ACT2	Enables initiation of XML application from Program Key2. Key information : PK2	String	*1	Null

Model: HDV230

The phone can access to initial URL by press softkey/ flexiblekey/DSS key

Configuration Parameter	Description	Format	Value Range	Default Value
XML_INITIATE_KEY_SOFT1	Enables initiation of XML application from Soft Key1. Key information : SOFT1	Boolean	Y/N	N
XML_INITIATE_KEY_SOFT2	Enables initiation of XML application from Soft Key2. Key information : SOFT3	Boolean	Y/N	N
XML_INITIATE_KEY_SOFT3	Enables initiation of XML application from Soft Key3. Key information : SOFT3	Boolean	Y/N	N
FLEX_BUTTON_FACILITY_ACTx (X=1-24)	Enables initiation of XML application from Flexible key(1-24). Key information : FF1 - FF24	String	*1	Null
DSS_BUTTON_FACILITY_ACTx (x=1-200)	Enables initiation of XML application from DSS key(1-200). Key information : DSS1 - 200	String	*1	Null

Model:HDV330/430

The phone can access by pressed flexiblekey/DSS key

Configuration Parameter	Description	Format	Value Range	Default Value
FLEX_BUTTON_FACILITY_ACTx (X=1-24)	Enables initiation of XML application from Flexible key(1-24). Key information : FF1 - FF24	String	*1	Null
DSS_BUTTON_FACILITY_ACTx (x=1-200)	Enables initiation of XML application from DSS key(1-200). Key information : DSS1 - 200	String	*1	Null

*1 Set "X_PANASONIC_IPTTEL_APPLICATION"(string) to this parameters,

4.3.5.2. Initiation key operations

If the configuration parameter, "XMLAPP_INITIAL_URL", is specified, and if the above-mentioned parameter

is set to "Y" or "X_PANASONIC_IPTTEL_APPLICATION", when the corresponding key is pressed, the phone accesses to the URL, "XMLAPP_INITIAL_URL", adding CGI parameter of initiation key information.

e.g.)

Model: HDV130

HTTP GET /xmlpath/xmlapl.cgi ?initiationkey=SOFT1

or

HTTP GET /xmlpath/xmlapl.cgi ?initiationkey=PK1

Model: HDV230

HTTP GET /xmlpath/xmlapl.cgi ?initiationkey=SOFT1

or

HTTP GET /xmlpath/xmlapl.cgi ?initiationkey=FF1

or

HTTP GET /xmlpath/xmlapl.cgi ?initiationkey=DSS1

Model: HDV330/430

HTTP GET /xmlpath/xmlapl.cgi ?initiationkey=FF1

or

HTTP GET /xmlpath/xmlapl.cgi ?initiationkey=DSS1

This operation is only effective in the idle state of the phone.

4.3.6. Redial key Configuration and operation

4.3.6.1. Configuration Parameter

Configuration parameters are as follows.

Configuration Parameter	Description	Format	Value Range	Default Value
XMLAPP_URL_REDIAL_KEY	Specify the XML URL to acquire when the [REDIAL] key is selected.	String	Max. 256 characters	Empty String

4.3.6.2. Redial key operations

<HDV130/230/330/430>

If the configuration parameter, "XMLAPP_URL_REDIAL_KEY", is specified, and when [REDIAL] key is pressed, the phone access to the above-mentioned URL.

4.3.7. Cursor skip Configuration and operation

4.3.7.1. Configuration Parameter

Configuration parameters are as follows.

Configuration Parameter	Description	Format	Value Range	Default Value
XML_CURSOR_SKIP_ENABLE	Enables skip first line to display cursor, when showing XML Menu.	Boolean	Y/N	N

4.3.7.2. Cursor skip operation

Please refer 5.2.7.

5. XML Structure

5.1. XML Document

XML Document is consisted of XML declaration and instance. XML Document file has ".xml" extension.

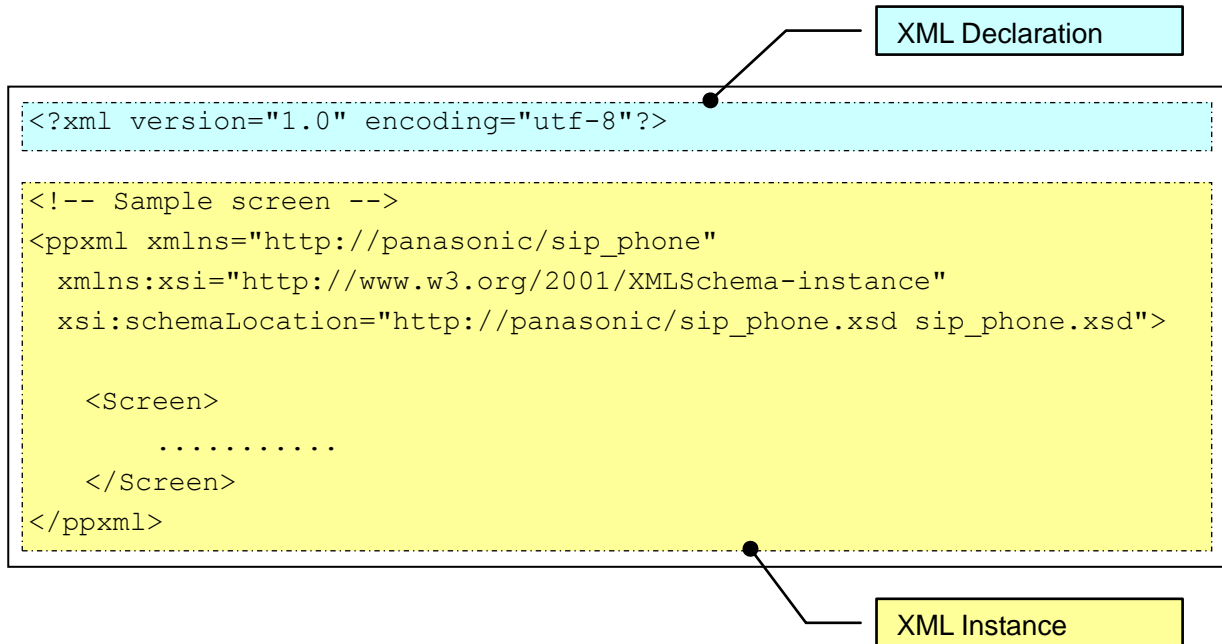

[XML Declaration]

XML version and character set are described. See below.

```
<?xml version="1.0" encoding="utf-8"?>
```

XML version must be "1.0".
Character set must be "UTF-8".

[XML Instance]

XML data defined by this document are described.

5.1.1. XML Schema of the phone

There are following XML schema which defines words and types, formats of all XML object. XML schema file has ".xsd" extension and uses "http://www.w3.org/2001/XMLSchema" namespace. These schema files should be copied onto the same folder as the XML contents folder for editing.

NO	Schema File (.xsd)	Description
1	sip_phone	Common schema for all xml contents
2	value_restrict.xsd	This definition is included from sip_phone
3	common.xsd	This definition is included from sip_phone
4	Events.xsd	This definition is included from sip_phone
5	ppxml_contents.xsd	This definition is included from sip_phone
6	Key.xsd	This definition is included from sip_phone
7	Screen_object.xsd	This definition is included from sip_phone

5.1.2. Name Space of XML Document

Name Space is declared in ppxml node.

XML document uses each XML schema of the phone corresponding to itself.

The formula is following:

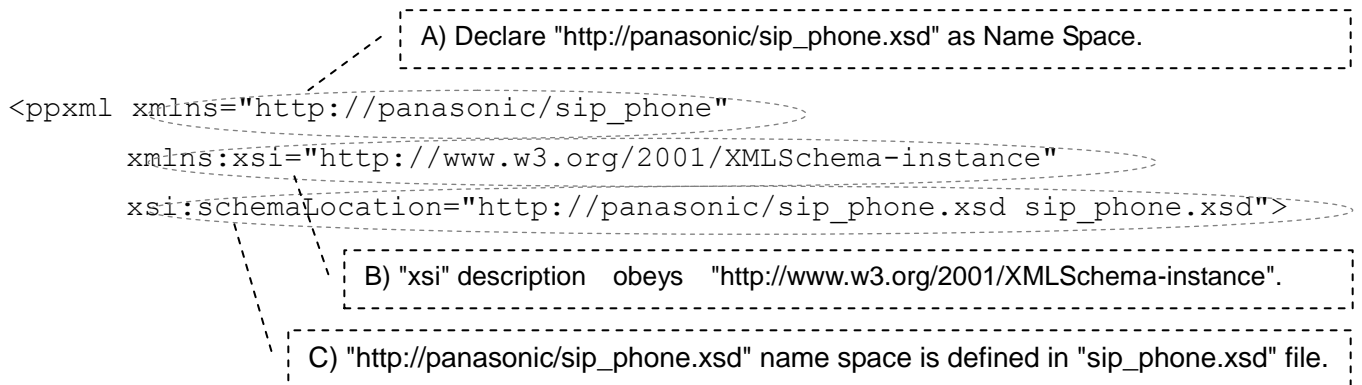

User has to change the description of A) and C) corresponding to target xml data.

5.1.3. Character reference

5.1.3.1. Predefined Entities in XML

The XML specification defines five "predefined entities" representing special characters, and requires that all XML processors honor them.

The table below lists the five XML predefined entities.

The "Name" column mentions the entity's name.

The "Character" column shows the character, if it is renderable. In order to render the character, the format `&name;` is used; for example, `&` renders as `&`.

The "Description" column cites the character via its canonical UCS/Unicode name, in English.

Character	Name	Description
"	<code>&quot;</code>	Quotation mark
&	<code>&amp;</code>	Ampersand
'	<code>&apos;</code>	Apostrophe
<	<code>&lt;</code>	Less-than sign
>	<code>&gt;</code>	Greater-than sign

5.1.3.2. Numeric Character Reference

A numeric character reference refers to a character by its Unicode (UTF-8) code point, and uses the following format

```
&#nnnn;
&#xhhhh;
```

nnnn is the code point in decimal form, and hhhh is the code point in hexadecimal form. The x must be lowercase in XML documents. The nnnn or hhhh may be any number of digits and may include leading zeros. The hhhh may mix uppercase and lowercase.

5.1.4. XML Object Outline

The following table is an outline of main XML objects.

Element	Functionality
<u>ppxml</u>	Root element
<u>Screen</u>	Screen object is same as Window of UI.
<u>Components</u>	Components object is correction of UI control object mainly.
<u>Label</u>	It displays the text string, date-time. (*1)
<u>PictureBox</u>	It displays BMP format data.
<u>TextBox</u>	It enables the user to enter and modify the text.
<u>Softkeys</u>	Soft keys definition.
<u>FFKeys</u>	FF keys definition.
<u>Pagekeys</u>	Page keys definition.
<u>Menu</u>	It displays Menu items.
<u>PhoneBook</u>	It displays Network Phonebook using built in phonebook UI. (*1)
<u>Softkeys</u>	Soft keys definition.
<u>FFKeys</u>	FF keys definition.
<u>Pagekeys</u>	Page keys definition. (*2)
<u>Events</u>	Events are an object to catch events. Events can also have some "Actions".
<u>Timer</u>	It is able to define timer period and actions at the expiration. (*1)
<u>Softkeys</u>	Soft keys definition.
<u>FFKeys</u>	FF keys definition.
<u>Pagekeys</u>	Page keys definition. (*2)
<u>Redialkey</u>	Redial key definition.
<u>Trigger</u>	It is used for the Push Service initiated from the server. (*1)
<u>SetVariables</u>	It provides the global variable which is available until rebooting.
<u>Execute</u>	Execute defines the operations (Reboot, SetXmlMode).

Note.

(*1): TGP600 supports only these elements.

(*2): HDV230/330/430 supports only these elements.

*Screen version: TGP600 - 2.0, HDV100/130/230/330/430 - 2.0/3.0

*Trigger version: TGP600 - 2.0, HDV100/130/230/330/430 - 2.0/3.0

5.2. XML Object Definition

[Common Rule / Condition]

Item	Rule / Condition	Note
m/o	'm/o' means 'mandatory / optional'.	
element / attribute	Describe the capital letter and the small letter accurately regarding the elements and attributes.	
name attribute	Only alphabets and numerals {A-Z, a-z, 0-9} can be used in the name attribute. All punctuation marks (!"#\$%&'()-+=~/<>* ...), space, and underscore cannot be used.	
	It should be unique over the entire xml contents. Especially, the name of the following elements must be absolutely unique. Screen, Label, PictureBox, Textbox, SoftKey, FFKKey, PageKey, Timer	
Operation by hard key	The object operation with a hard key is invalid if there is no special description.	

5.2.1. ppxml

[Overview]

"ppxml" object is **root element**.

This element is mandatory to define XML data.

[Definition]

Child Element	Attribute	Value	m/o
	xmlns	http://panasonic/sip_phone	m
	xmlns:xsi	http://www.w3.org/2001/XMLSchema-instance	m
	xsi:schemaLocation	http://panasonic/sip_phone sip_phone.xsd	m
Screen	*Please refer to the element definition		o
Trigger	*Please refer to the element definition		o
SetVariables	*Please refer to the element definition		o
SoftKeys	*Please refer to the element definition		o
FFKeys	*Please refer to the element definition		o
PageKeys	*Please refer to the element definition		o
Execute	*Please refer to the element definition		o
Redialkey	*Please refer to the element definition		o

[Syntax]

```
<?xml version="1.0" encoding="utf-8"?>

<ppxml xmlns="http://panasonic/sip_phone"
        xmlns:xsi="http://www.w3.org/2001/XMLSchema-instance"
        xsi:schemaLocation="http://panasonic/sip_phone sip_phone.xsd">
  <Screen>
    <!-- Describe XML items -->
  </Screen>
  <SetVariables>
    <SetVariable key="@MyNameSystemWideValue" value="MyName" />
  </SetVariables>
</ppxml>
```

[LCD Image]

None

5.2.2. Screen

[Overview]

Screen object is same as Window of GUI.
This can have some components.

[Definition]

Child Element1	Child Element2	Attribute	Value	m/o	Functionality
		name	String	o	Max. 64 characters
		version	"2.0", "3.0" (*1)	o	
Components		<u>*Please refer to the element definition</u>		o	
PhoneBook		<u>*Please refer to the element definition</u>		o	
Timer		<u>*Please refer to the element definition</u>		o	
Menu		<u>*Please refer to the element definition</u>		o	
SoftKeys		<u>*Please refer to the element definition</u>		o	
FFKeys		<u>*Please refer to the element definition</u>		o	
PageKeys		<u>*Please refer to the element definition</u>		o	
Events	OnTalking	<u>*Please refer to the element definition</u>		o	
	OnHungup	<u>*Please refer to the element definition</u>		o	
	OnClicked	<u>*Please refer to the element definition</u>		o	
	OnExpired	<u>*Please refer to the element definition</u>		o	

Note. (*1) .TGP600 supports only Version 2.0.

[Syntax]

```
<?xml version="1.0" encoding="utf-8"?>

<ppxml
  xmlns="http://panasonic/sip_phone"
  xmlns:xsi="http://www.w3.org/2001/XMLSchema-instance"
  xsi:schemaLocation="http://panasonic/sip_phone sip_phone.xsd">

  <Screen name="Screen1" version="3.0">
    <Components>
      <!-- Describe XML items -->
    </Components>
  </Screen>

</ppxml>
```

[LCD Image]

None

5.2.3. Components

[Overview]

Components object is correction of GUI control object mainly.

All GUI controls (Button, Checkbox etc.) are optional.

Components are optional for main XML screen.

As for popup/dialog "Components" are mandatory.

[Definition]

Child Element	m/o	Functionality
<u>Label</u>	o	It displays the text string (TGP600 up to 16 strings/ HDVseries up to 32strings)
<u>PictureBox</u>	o	It displays BMP format data.
<u>TextBox</u>	o	It enables the user to enter and modify the text.
<u>SoftKeys</u>	o	Button is an object pushed by user.
<u>FFKeys</u>	o	Almost same as Button. Added attributes(border,margin,text)
<u>PageKeys</u>	o	It selects one from a mutually exclusive set of options.
<u>Redialkey</u>	o	When the user pushes the REDIAL key, the phone access to the outgoing log data that are stored on the XML server.

[Syntax]

```
<?xml version="1.0" encoding="utf-8"?>
```

```
<ppxml
```

```
  xmlns="http://panasonic/sip_phone"
```

```
  xmlns:xsi="http://www.w3.org/2001/XMLSchema-instance"
```

```
  xsi:schemaLocation="http://panasonic/sip_phone sip_phone.xsd">
```

```
  <Screen name="Screen1" version="3.0">
```

```
    <Components>
```

```
      <Label name="Label1" line="2" text="Label1" textAlignment="Left" area="Phone" />
```

```
      <TextBox name="TextBox2" area="Phone" line="3" text="TextBox2" textAlignment="Left" />
```

```
      <PictureBox name="PictureBox1" left="0" top="0" width="120" height="55" source="http://aaa/bbb/ccc/pic1.bmp" />
```

```
    </Components>
```

```
  </Screen>
```

```
</ppxml>
```

[LCD Image]

None

[Note]

In the following model, PictureBox of above [Syntax] is as follows.

<HDV330/430> * Height of status bar is 27 pixels.

```
<PictureBox name="PictureBox1" left="0" top="27" width="120" height="55" source="http://aaa/bbb/ccc/pic1.bmp" />
```

5.2.4. Label

[Overview]

A label is a user interface control which displays text on a form. It is usually a static control; having no interactivity.

A label is generally used to identify a nearby text box or other widget.

Label is able to display single line. Multiple line text can't.

Actual string display priority of label is shown as below:

Highest priority Lowest priority
showDateTime text

[Definition]

Child Element	Attributes	Value	m/o	Functionality
	name	String	m	Max. 64 characters
	area	Phone	o	Fixed area: Phone
	line	1~4 (4 line model) (HDV130/230) 1~6 (6 line model) (HDV330/430)	m	The line number to display the string
	text	Displayed string	m	Content text in the label field.
	textAlignment	Left/Center/Right	o	Default=Left
	showDateTime	true/false	o	Default=false
	refreshDateTime	0~86400	o	In second(s) Default=0 0 means no refresh

[Syntax]

```
<?xml version="1.0" encoding="utf-8"?>

<ppxml
  xmlns="http://panasonic/sip_phone"
  xmlns:xsi="http://www.w3.org/2001/XMLSchema-instance"
  xsi:schemaLocation="http://panasonic/sip_phone sip_phone.xsd">

  <Screen version="3.0">
    <Components>
      <!-- Label's example declaration -->
      <Label name="labelTitle" area="Phone" line="2"
        text="Screen title" textAlignment="Left" />
      <!-- Label's minimal declaration -->
      <Label name="labelName" line="3" text="Name"/>
      <!-- Label's other example -->
      <Label name="lbl123" area="Phone" line=" "
        text=" " textAlignment="Left"
        showDateTime="true" refreshDateTime="18000"/>
    </Components>
  </Screen>
</ppxml>
```

[Displayable Area]

[4 line model]

<HDV130/230>

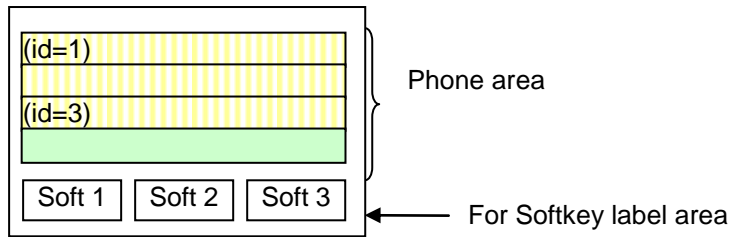

[6 line model]

<HDV330/430>

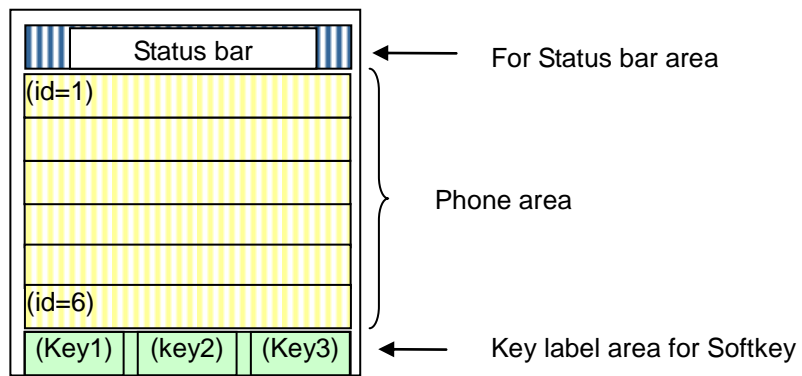

5.2.5. PictureBox

[Overview]

By using Picture Box, phone can display Images with BMP format data.
It is able to display company logo.

[Definition]

Child Element	Attribute	Value	m/o	Description
	name	Picture box name	m	Max. 64 characters
	left	0~131 (HDV130/230) 0~479 (HDV330/430)	m	Horizontal Position of BMP
	width	1~132 (HDV130/230) 1~480 (HDV330/430)	m	Width of BMP
	top	0~ 63 (HDV130/230) 27~271(HDV330/430)	m	Vertical Position of BMP
	height	1~ 64 (HDV130/230) 1~245 (HDV330/430)	m	Height of BMP
	source	Url	m	URL of BMP

[Syntax]

```
<?xml version="1.0" encoding="utf-8"?>
<ppxml xmlns="http://panasonic/sip_phone"
xmlns:xsi="http://www.w3.org/2001/XMLSchema-instance"
xsi:schemaLocation="http://panasonic/sip_phone sip_phone.xsd">

  <Screen name="Screen" version="3.0">
    <Components>
      <PictureBox name="PictureBox1" left="0" top="0" width="120"
        height="55" source="http://192.168.0.113/xml/pana.bmp" />
    </Components>
  </Screen>
</ppxml>
```

[Note]

In the following model, PictureBox of above [Syntax] is as follows.
<HDV330/430> * Height of status bar is 27 pixels.

```
<PictureBox name="PictureBox1" left="0" top="27" width="120"
  height="55" source="http://192.168.0.113/xml/pana.bmp" />
```

5.2.6. TextBox

[Overview]

By using Text Box, user can enter and modify the text.

Text Box can enter single line text.

Password characters can be masked by '*'.
 Input / modification of text box can be done through phone key operation.

The value input by Text Box can be sent to pre specified URL when user press [ENTER] Key.

[Definition]

Child Element 1	Child Element 2	Child Element 3	Child Element 4	Attributes	Value	m/o	Functionality
				name	String	m	Max. 64 characters
				line	2~3 (4line model)	m	The line number to display the string
				text	String	o	Max. 24 characters
				password	true/false	o	Display inputted character with '*'. Default value is false.
				mode	0,1	o	0:Enter Number 1:Enter Character
SoftKey						m	
				id	2 (HDV130/230) 3 (HDV330/430)	m	Softkey id
				name	String	o	name of the softkey
				text	"OK"	m	Fixed character "OK"
Events						m	Elements except these cannot be used
				OnClick		m	
				SendRequest		m	
				url	Url	m	

[Syntax]

```
<ppxml xmlns="http://panasonic/sip_phone"
xmlns:xsi="http://www.w3.org/2001/XMLSchema-instance"
xsi:schemaLocation="http://panasonic/sip_phone sip_phone.xsd">
```

```
<Screen name="Screen" version="3.0">
```

```
<Components>
```

```
<TextBox name="textBox" title="Name" line="2"
```

```
text="<Enter>" password="false">
```

```
<SoftKey id="2" name="sk2" text="OK">
```

```
<Events>
```

```
<OnClick>
```

```
<SendRequest url="http://192.168.0.200/text_input.cgi" />
```

```
</OnClick>
```

```
</Events>
```

```
</SoftKey>
```

```
</TextBox>
```

```
</Components>
```

```
</Screen>
```

HDV330/430 Soft key ID is 3
 <SoftKey id="3" name="sk3" text="OK">

</ppxml>

In the following model, TextBox of above [Syntax] is as follows.

```
<HDV330/430> Soft key ID is 3  
<SoftKey id="3" name="sk3" text="OK">
```

[Displayable Area]

[c.f. 5.2.4. Label](#)

[LCD Image]

<HDV130/230>

mode = 1 : Character

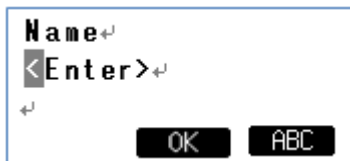

mode = 0 : Number

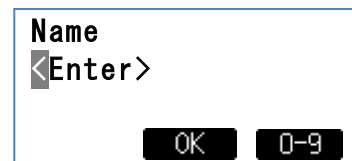

<HDV330/430>

mode = 1 : Character

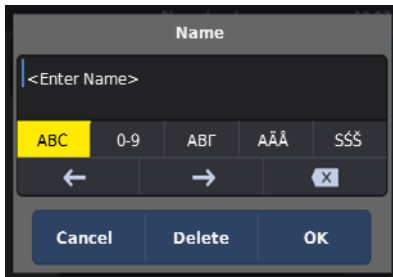

mode = 0 : Number

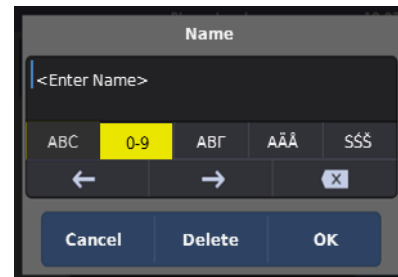

[Note]

<HDV130/230>

- Text box can be used as Only 1 line.
- Line number 2 ~ 3 is available to display input Text Box
- The maximum length can be input is the length phone can display in 1 line.

<HDV330/430>

- Text box can be used as Only 1 line at title bar. However, it could be changed as "Edit".
For example, <TextBox name="textBox1" -> "Edit" at title bar.
- The maximum length can be input is the length phone can display in 1 line.
32 characters / 1 line
24 characters / 1 text (Title bar)

HDV330/430 ignore designation of softkey. Always treat softkey3 as "OK".

<HDV130/230>

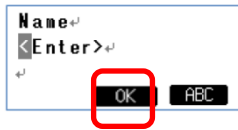

<SoftKey id=" 2" name="sk2" text="OK">

<HDV330/430>

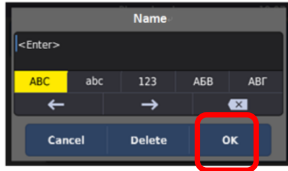

<SoftKey id=" 3" name="sk3" text="OK">

or

<SoftKey id=" 2" name="sk2" text="OK">

HDV330/430 ignores this designation.

User can use same designation of HDV130/230.

So, No need to change XML server code.

5.2.7. Menu

[Overview]

"Menu" element is able to link with flexible function key. When push the key, the phone will access to the defined url.

"Menu" element is used in Phone display area.

[Definition of Key Actions]

Key	Action of the key
Navigator keys	Only Up & Down key; move selecting item
Enter key	Select the item and execute it
Soft keys	Define soft key's action in XML content

A user can select the menu item to use navigation key (up & down) and execute it to use enter key.

Selecting item displays with monochrome reversed character at the line, which only in phone area.

The item top on the left side will be monochrome reversed when after moving menu page.

FF keys and Soft keys have to be defined the action in XML content.

[Definition]

Child Element 1	Child Element 2	Child Element 3	Attribute	Value	m/o	Functionality
			name	String	o	Max. 64characters
			area	Phone	o	Fixed area: Phone
Menuitem					m	each menu item
			id	1~20	m	Menu item position (The lower number is upper position.)
			name	String	o	Max. 64characters
			text	String	m	Max. 24 characters.
			textAlignment	Left/Center/Right	o	default: Left
			selected	true/false	o	default: false Selected Status of menu as default
	Events				o	
		OnClicked			m	
SoftKeys					o	
FFKeys					o	
PageKeys					o	

[Syntax]

```
<?xml version="1.0" encoding="utf-8"?>

<ppxml
  xmlns="http://panasonic/sip_phone"
  xmlns:xsi="http://www.w3.org/2001/XMLSchema-instance"
  xsi:schemaLocation="http://panasonic/sip_phone sip_phone.xsd">

  <Screen version="3.0">
    <!--Assign function to Menu items and soft keys -->
    <Menu name="MainMenu" area="Phone">
      <MenuItems>
        <MenuItem name="Item1" text="123" selected="true" id="1">
          <Events>
            <OnClicked>
              <SendRequest url="http://192.168.0.200/gogo.xml" />
            </OnClicked>
          </Events>
        </MenuItem>
        <MenuItem name="Item2" text="hello" id="2">
          <Events>
            <OnClicked>
              <SendRequest url="http://192.168.0.200/hello.xml" />
            </OnClicked>
          </Events>
        </MenuItem>
        <MenuItem name="Item3" text="welcom" id="3">
          <Events>
            <OnClicked>
              <SendRequest url="http://192.168.0.200/welcome.xml" />
            </OnClicked>
          </Events>
        </MenuItem>
      </MenuItems>
      <SoftKeys>
        <SoftKey id="1" name="sk1" text="Cancel">
          <Events>
            <OnClicked>
              <SendRequest url="http://192.168.0.200/Cancel.xml" />
            </OnClicked>
          </Events>
        </SoftKey>
        <SoftKey id="2" name="sk2" text="Enter">
          <Events>
            <OnClicked>
              <SendRequest url="http://192.168.0.200/Enter.xml" />
            </OnClicked>
          </Events>
        </SoftKey>
      </SoftKeys>

    </Menu>
  </Screen>
</ppxml>
```

[Displayable Area]

[4 line model]

<HDV130/230>

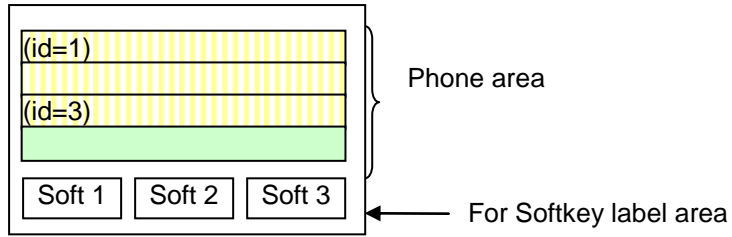

[6 line model]

<HDV330/430>

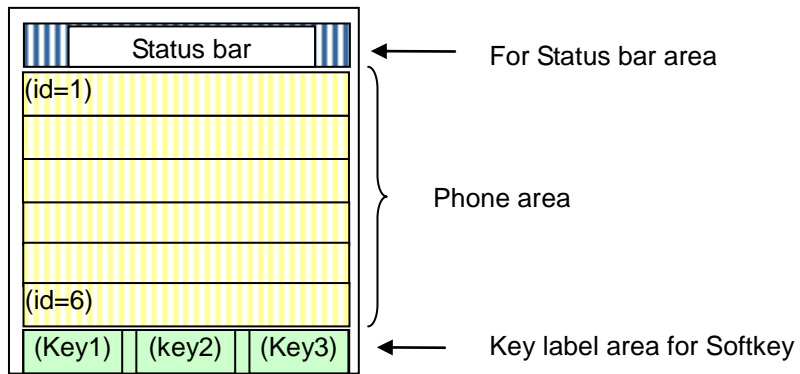

[LCD Image]

<HDV130/230>



<HDV330/430>



<HDV130/230> [4 line model]

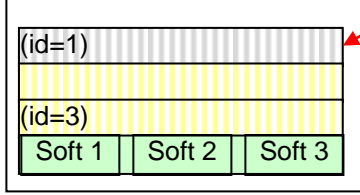

XML_CURSOR_SKIP_ENABLE=N (Default)

Cursor can move to this area



Cursor CANNOT move to this area

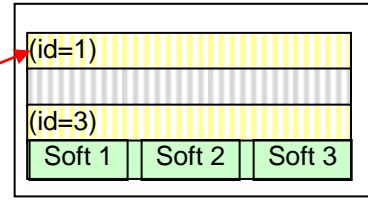

XML_CURSOR_SKIP_ENABLE=Y

<HDV330/430> [6 line model]

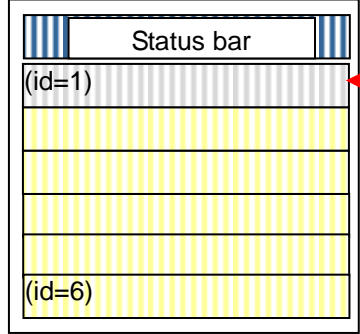

XML_CURSOR_SKIP_ENABLE=N (Default)

This area is selectable.



This area is NOT selectable.

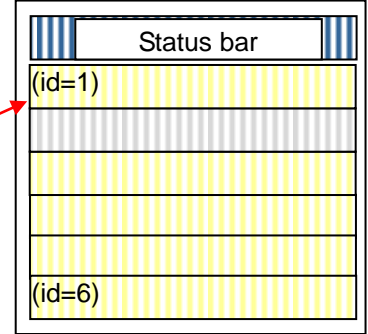

XML_CURSOR_SKIP_ENABLE=Y

5.2.8. PhoneBook

[Overview]

It is able to perform the same operability as embedded phonebook to the network phonebook by using this element.

[Definition]

Child Element1	Child Element2	Child Element3	Attribute	Value	m/o	Functionality	
			version	"2.0" ,"3.0"	o		
Personnel			id	1-20 (1-10 for Japanese model)	m	displaying order	
	Name			Text	m	Max. 24 characters.	
	Ruby			Text	o	Max. 24 characters. except '&'<>	
	PhoneNums				o		
		PhoneNum			0~9, #, *	m	1~32 digits
				type	ext, company, mobile, home, etc.	m	

[Syntax]

```
<?xml version="1.0" encoding="utf-8"?>
<ppxml
  xmlns="http://panasonic/sip_phone"
  xmlns:xsi="http://www.w3.org/2001/XMLSchema-instance"
  xsi:schemaLocation="http://panasonic/sip_phone sip_phone.xsd">

  <Screen version="3.0">
    <PhoneBook version="2.0">

      <Personnel id="1">
        <Name>David Allan</Name>
        <PhoneNums>
          <PhoneNum type="ext">3920</PhoneNum>
          <PhoneNum type="home">99998888</PhoneNum>
        </PhoneNums>
      </Personnel>

      <Personnel id="2">
        <Name>George</Name>
        <PhoneNums>
          <PhoneNum type="ext">223</PhoneNum>
          <PhoneNum type="mobile">088011</PhoneNum>
          <PhoneNum type="company">999</PhoneNum>
        </PhoneNums>
      </Personnel>

    </PhoneBook>
  </Screen>
</ppxml>
```

[LCD Image]

[c.f. 4.3.2.2. Network Phonebook Operations](#)

5.2.9. Events

[Overview]

Events are an object to catch events.

The trigger of Events is raised from following cases:

- Normal Event: Respond to a user operation for components.

An event can have some "Actions".

Action is an object to define a process for an event.

An event can have the plural Actions. Each Action is sequentially executed. (The maximum actions allowed to 5, per event.)

[Definition]

Child Element 1	Child Element 2	Attributes	Value	m/o	Functionality
On Talking				o	System Event: This is issued when call state changed to talking state.
	SendRequest			o	Get request to web server.
		url	Url	m	Max. 511 characters
MakeCall				o	Call to specified phone number.
		number	Phone number 0 - 9, #, *	m	1~32 digits
AnswerCall				o	Answer incoming call.
HangupCall				o	Hang-up the call.
SetXmlMode				o	This element is the same as 'Enable Application'. c.f.) 4.1. The phone will reboot after changing.
		mode	on/off	m	
Reboot				o	Reboot the phone.
CancelKey				o	Execute "Cancel" key operation.
MissedCallOff				o	Don't display "Missed Call:XX"
OnHungup				o	System Event: This is issued when a call is hang up.
	Same Child elements of "OnTalking".			o	
OnClicked				o	This is issued when Key is pressed.
	Same Child elements of "OnTalking".			o	
OnExpired				o	This is issued when Timer expired.
	Same Child elements of "OnTalking".			o	

[Syntax]

1. Event which caused by operation of menu and soft keys.

```
<ppxml
  xmlns="http://panasonic/sip_phone"
  xmlns:xsi="http://www.w3.org/2001/XMLSchema-instance"
  xsi:schemaLocation="http://panasonic/sip_phone sip_phone.xsd">

  <Screen version="3.0>
    <!--Display Menu Item and assign function to FF Keys and Soft Keys -->
    <Menu name="MainMenu" area="Phone">
      <MenuItems>
        <MenuItem name="Item1" text="123" selected="true" id="1">
          <Events>
            <OnClicked>
              <AnswerCall />
            </OnClicked>
          </Events>
        </MenuItem>
      </MenuItems>
    </Menu>
  </Screen>
</ppxml>
```

```

<MenuItem name="Item2" text="abc" id="2">
  <Events>
    <OnClicked>
      <HangupCall />
    </OnClicked>
  </Events>
</MenuItem>
<MenuItem name="Item3" text="111" id="3">
  <Events>
    <OnClicked>
      <MakeCall number="#123456" />
    </OnClicked>
  </Events>
</MenuItem>
<MenuItem name="Item4" text="222" id="4">
  <Events>
    <OnClicked>
      <Reboot />
    </OnClicked>
  </Events>
</MenuItem>

</MenuItems>
<SoftKeys>
  <SoftKey id="4" name="sk4" text="Cancel">
    <Events>
      <OnClicked>
        <SendRequest url="http://192.168.0.200/Cancel.xml" />
      </OnClicked>
    </Events>
  </SoftKey>
</SoftKeys>
<FFKeys>
  <FFKey id="1" name="ff1" text="FFKey1">
    <Events>
      <OnClicked>
        <SendRequest url="http://192.168.0.200/gogo.xml" />
      </OnClicked>
    </Events>
  </FFKey>
</FFKeys>
</Menu>
</Screen>
</ppxml>

```

2. Events which caused by during a call.

```

<ppxml>
  <Screen version="3.0">
    <Components>
      <Label text="Transfer" name="Lb11" line="1" textAlignment="Left" />
    </Components>
    <Events>
      <OnTalking>
        <SendRequest url="http://192.168.0.200/Cancel.xml" />
      </OnTalking>
    </Events>
  </Screen>
</ppxml>

```

[Operations]

[SendRequest]

SendRequest is used to get XML data from Web Server.

SendRequest sends "HTTP GET Request" which has some parameters.

The format of the parameter is same as one of the <FORM> tag.

Components which can be the parameter are followings.

Components	Parameter Name	Parameter Value
TextBox	name	String

The scope of Names and Values which are sent by "SendRequest" is <Screen>.

[Restrictions]

1. When a button is clicked, a new thread is created to process the actions.

If the actions have not completed, clicking the same button has no effect.

If the actions have not completed, clicking another button/control will trigger another button/control's actions.

2. If multiple actions are declared within a button, the actions will always be executed in sequential manner.

Asynchronize action must also be completed before next action can start.

[Reboot actions]

Reboot actions can be defined as following types.

Though these actions are processed as normal action, <Trigger> may be sent from Web Server by PUSH.

[Type 1]

```
<?xml version="1.0" encoding="utf-8"?>
<ppxml
  xmlns="http://panasonic/sip_phone"
  xmlns:xsi="http://www.w3.org/2001/XMLSchema-instance"
  xsi:schemaLocation="http://panasonic/sip_phone sip_phone.xsd">

  <Screen version="3.0">
    <Events>
      <OnHangup>
        <Reboot />
      </OnHangup>
    </Events>
  </Screen>

</ppxml>
```

[Type 2]

```
<?xml version="1.0" encoding="utf-8"?>
<ppxml
  xmlns="http://panasonic/sip_phone"
  xmlns:xsi="http://www.w3.org/2001/XMLSchema-instance"
  xsi:schemaLocation="http://panasonic/sip_phone sip_phone.xsd">
```

```

<Screen version="3.0">
  <Timer name="Timer1" interval="60" repeat="false">
    <Events>
      <OnExpired>
        <Reboot />
      </OnExpired>
    </Events>
  </Timer>
</Screen>
</ppxml>

```

[Type 3]

```

<?xml version="1.0" encoding="utf-8"?>
<ppxml
  xmlns="http://panasonic/sip_phone"
  xmlns:xsi="http://www.w3.org/2001/XMLSchema-instance"
  xsi:schemaLocation="http://panasonic/sip_phone sip_phone.xsd">

  <Execute>
    <SetXmlMode mode="on" />
    <Reboot />
  </Execute>

</ppxml>

```

[Type 4]

```

<?xml version="1.0" encoding="utf-8"?>
<ppxml
  xmlns="http://panasonic/sip_phone"
  xmlns:xsi="http://www.w3.org/2001/XMLSchema-instance"
  xsi:schemaLocation="http://panasonic/sip_phone sip_phone.xsd">

  <Screen name="Screen1" version="3.0">
    <Menu name="MainMenu" area="Phone">
      <MenuItems>
        <MenuItem name="Item4" text="222" id="5">
          <Events>
            <OnClicked>
              <Reboot />
            </OnClicked>
          </Events>
        </MenuItem>
      </MenuItems>
    </Menu>
  </Screen>

</ppxml>

```

5.2.10. SoftKeys

[Overview]

"SoftKeys" element has to include one or more "SoftKey" elements.

"SoftKey" element can define in the "Screen" or "Menu" element.

It will not act anything, when pushing Softkey which is not assigned any feature(URL) in XML application mode.

[Definition]

Child Element 1	Child Element 2	Child Element 3	Attribute	Value	m/o	Functionality
SoftKey					m	
/			id	1~3	m	softkey id
/			name	String	o	Max. 24 characters.
/			text	String	m	Max. 24 characters
Events					m	
/			OnClicked		m	

[Syntax]

Soft Key with "Cancel".

```
<?xml version="1.0" encoding="utf-8"?>

<ppxml
  xmlns="http://panasonic/sip_phone"
  xmlns:xsi="http://www.w3.org/2001/XMLSchema-instance"
  xsi:schemaLocation="http://panasonic/sip_phone sip_phone.xsd">

  <Screen version="3.0">
    <Components>
      <SoftKey id="3" name="sk3" text="Cancel">
        <Events>
          <OnClicked>
            <SendRequest url="http://192.168.0.200/Cancel.xml" />
          </OnClicked>
        </Events>
      </SoftKey>
    </Components>
  </Screen>
</ppxml>
```

[LCD Image]

(For example) SoftKey id="3" name="sk3" text="Cancel"

<HDV130/230>

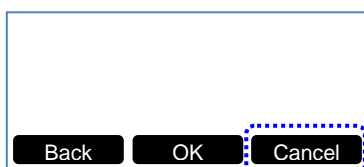

<HDV330/430>

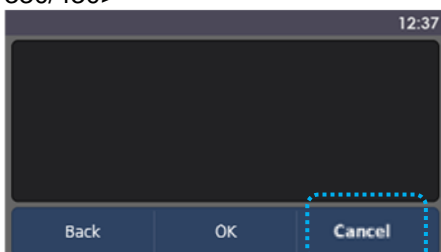

5.2.11. FFKeys

[Overview]

"FFKeys" element has to include one or more "FFKey" elements.

"FFKeys" element can define in the "Screen" or "Menu" element.

It will not act anything, when pushing FFkey which is not assigned any feature (URL) in XML application mode.

[Definition]

Child Element 1	Child Element 2	Attribute	Value	m/o	Functionality
		id	1~2 (HDV130) 1~12 (HDV230) 1~8 (HDV330/430)	m	FFKey id
		name	String	o	Max. 24 characters.
		text	String(HDV230/330/430)	m	
		optional	String(HDV130)	o	
Events				m	
	OnClicked			m	

[Syntax]

```
<?xml version="1.0" encoding="utf-8"?>
```

```
<ppxml
```

```
  xmlns="http://panasonic/sip_phone"
```

```
  xmlns:xsi="http://www.w3.org/2001/XMLSchema-instance"
```

```
  xsi:schemaLocation="http://panasonic/sip_phone sip_phone.xsd">
```

```
<Screen version="3.0">
```

```
<Components>
```

```
<FFKey id="4" name="ff4" text="Cancel">
```

```
<Events>
```

```
<OnClicked>
```

```
<SendRequest url="http://192.168.0.200/Cancel.xml" />
```

```
</OnClicked>
```

```
</Events>
```

```
</FFKey>
```

```
</Components>
```

```
</Screen>
```

```
</ppxml>
```

<HDV330/430>

The "id" of attribute and FFkey display is as follows.

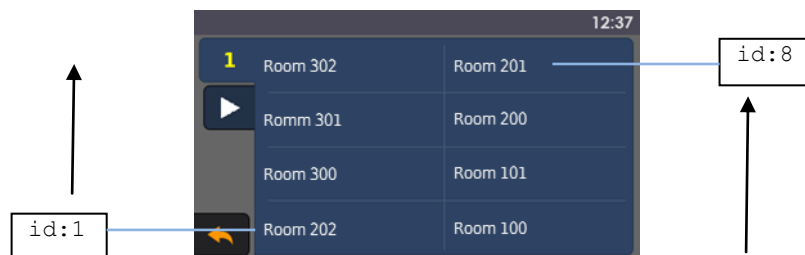

5.2.12. PageKeys(*1)

[Overview]

"PageKeys" element has to include one or more "PageKey" elements.

"PageKeys" element can define in the "Screen" or "Menu" element.

It will not act anything, when pushing PageKey which is not assigned any feature (URL) in XML application mode.

(*1) Supported only HDV230/330/430.

[Definition]

Child Element 1	Child Element 2	Child Element 3	Child Element 4	Attribute	Value	m/o	Functionality
PageKey						m	
				id	right	m	PageKey id
				name	String	o	Max. 24 characters.
Events						m	Only these elements can be described
				OnClicked		m	
				SendRequest		m	
				url	Url	m	

[Syntax]

```
<?xml version="1.0" encoding="utf-8"?>
```

```
<ppxml
```

```
  xmlns="http://panasonic/sip_phone"
```

```
  xmlns:xsi="http://www.w3.org/2001/XMLSchema-instance"
```

```
  xsi:schemaLocation="http://panasonic/sip_phone sip_phone.xsd">
```

```
<Screen version="3.0">
```

```
<Components>
```

```
<PageKey id="right" name="page1">
```

```
<Events>
```

```
<OnClicked>
```

```
<SendRequest url="http://192.168.0.200/page_pre.xml" />
```

```
</OnClicked>
```

```
</Events>
```

```
</PageKey>
```

```
</Components>
```

```
</Screen>
```

```
</ppxml>
```

<HDV330/430>

If  [Next Page] icon is tapped, the following next screen is displayed.

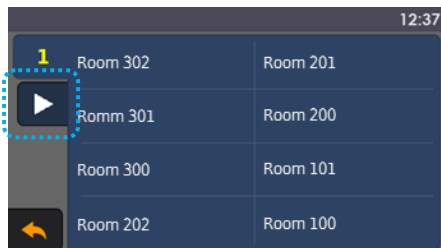

5.2.13. SetVariables

[Overview]

SetVariable is used to create & update system wide read/write variable.

The variable will store a string value that can be referring back at the later stage.

This variable life span is until system reboot.

This variable is registrable by 16 kinds or less.

[Naming Rule of Variables]

Rules of variable name:

- Can be any combinations of String (alphabet + number + Multi-byte character code)
- White space, symbol and special character are not allowed
- Example of valid variable name: @MyVariable123, @aB12Cd, @textBox1
- Example of invalid variable name: @MyName_Textbox, @Hello~!^%,

[Example usage of SetVariable]

- Store the XML server URL path,

```
<SetVariable key="@serverPath" value="http://192.168.0.100/path" />
```

- For referring the variables

Value which stored in variables can be referred by following way

```
<PictureBox name="PBox1" left="0" top="0" width="120" height="55" source="@serverPath/a.bmp" />
```

```
<HDV330/430>
```

```
<PictureBox name="PBox1" left="0" top="27" width="120" height="55" source="@serverPath/a.bmp" />
```

* Height of status bar is 27 pixels.

[Definition]

Child Element 1	Attribute	Value	m/o	Functionality
SetVariable			m	
	key	@ followed by a~z,A~Z,0~9 e.g. @myId, @food2	m	System wide read/write : Prefix character is @. 1~64 characters
	value	Except '&', "'", '<'	m	1~64 characters

[Syntax]

[To Set variables]

```
<ppxml
  xmlns="http://panasonic/sip_phone"
  xmlns:xsi="http://www.w3.org/2001/XMLSchema-instance"
  xsi:schemaLocation="http://panasonic/sip_phone sip_phone.xsd">
<Screen name="Screen1" version="3.0">
  <Components>
    <Label name="MyNameLabel" line="2" text="Label1"
      textAlignment="Left" showDateTime="true" refreshDateTime="52" />
  </Components>
</Screen>
<SetVariables>
  <SetVariable key="@SystemValue" value="MyNameLabel" />
</SetVariables>
</ppxml>
```

[To Refer variables]

```
<ppxml
  xmlns="http://panasonic/sip_phone"
  xmlns:xsi="http://www.w3.org/2001/XMLSchema-instance"
  xsi:schemaLocation="http://panasonic/sip_phone sip_phone.xsd">
```



```
<Screen>
  <Components>
    <Label name="Label1" line="2" text="@SystemValue"
      textAlignment="Left" showDateTime="true" refreshDateTime="52" />
  </Components>
</Screen>
</ppxml>
```

5.2.14. Timer

[Overview]

Developer can define a period of time, before the timer will trigger.

When timer triggers, developer can define any Actions (e.g. SendRequest, Make Call).

Timer will only stop if the current screen is being replaced.

Timer can only be exist one definition in XML content. Multiple timer event cannot executed

[Definition]

Child Element 1	Child Element 2	Attribute	Value	m/o	Functionality
		name	String	m	Max. 64 characters
		repeat	true/false	m	default: false
		interval	1~86400	m	In second(s)
Events				m	
	OnExpired			m	

[Syntax]

```
<ppxml>
  <Screen name="Screen" version="3.0">
    <Timer name="Timer1" repeat="false" interval="20">
      <Events>
        <OnExpired>
          <SendRequest url="http://aaa.ccc.com/GetXml.aspx?xml=HotelHome.xml"
            method="GET" />
        </OnExpired>
      </Events>
    </Timer>
  </Screen>
</ppxml>
```

5.2.15. Execute

[Overview]

Execute defines the operations that can be executed in the phone.

[Definition]

Child Element 1	Attribute	Value	m/o	Functionality
	version	"2.0", "3.0"	o	
Reboot			o	Refer to Reboot action in Events sheet
SetXmlMode			o	Refer to SetXmlMode action in Events sheet
CancelKey			o	Execute "Cancel" key operation.
MissedCallOff			o	Don't display "Missed Call:XX"

[Syntax]

```
<?xml version="3.0" encoding="utf-8"?>
```

```
<ppxml
```

```
  xmlns="http://panasonic/sip_phone"
```

```
  xmlns:xsi="http://www.w3.org/2001/XMLSchema-instance"
```

```
  xsi:schemaLocation="http://panasonic/sip_phone sip_phone.xsd">
```

```
  <Execute version="2.0">
```

```
    <SetXmlMode mode="on" />
```

```
    <Reboot />
```

```
  </Execute>
```

```
</ppxml>
```

5.2.16. Trigger

[Overview]

Trigger is usually used for Server Push request.

The phone acquires the XML file which URL is specified in the Source element value of the Trigger object.

[Definition]

Child Element 1	Attribute	Value	m/o	Functionality
	version	"2.0", "3.0" (*1)	o	
Source		Url	m	URL of XML content

Note. (*1) .TGP600 supports only Version 2.0.

[Syntax]

```
<?xml version="2.0" encoding="utf-8"?>
```

```
<ppxml  
  xmlns="http://panasonic/sip_phone"  
  xmlns:xsi="http://www.w3.org/2001/XMLSchema-instance"  
  xsi:schemaLocation="http://panasonic/sip_phone sip_phone.xsd">  
  
  <Trigger version="3.0">  
    <Source>http://www.aaa.ccc.com/Screen.xml</Source>  
  </Trigger>  
  
</ppxml>
```

5.2.17. Redialkey

[Overview]

When the Redial key is pushed, the phone acquires the outgoing data those are stored on the XML server instead of executing Last Number Redial.

[Definition]

Child Element 1	Child Element 2	Child Element 3	Child Element 4	Attribute	Value	m/o	Functionality
				name	String	o	Max. 24 characters.
	Events					m	Only these elements can be described
		OnClicked				m	
		SendRequest				m	
				url	Url	m	

[Syntax]

```
<?xml version="1.0" encoding="utf-8"?>
<ppxml
  xmlns="http://panasonic/sip_phone"
  xmlns:xsi="http://www.w3.org/2001/XMLSchema-instance"
  xsi:schemaLocation="http://panasonic/sip_phone sip_phone.xsd">
<Screen version="3.0">
  <Components>
    <RedialKey name="Call log">
      <Events>
        <OnClicked>
          <SendRequest url="http://192.168.0.200/Call_log.xml" />
        </OnClicked>
      </Events>
    </RedialKey>
  </Components>
</Screen>
</ppxml>
```

5.2.18. PhoneBook(like XSI format)

[Overview]

It is able to perform the same operability as embedded phonebook to the network phonebook by using this element. This format is like XSI phonebook format.

[Definition]

Child Element1	Child Element2	Child Element3	Attribute	Value	m/o	Functionality
			xml version	"1.0"	m	
			encoding	ISO-8859-1	m	
Group	startIndex			1	m	
	numberOfRecords			1-1000	m	
	totalAvailableRecords			1-1000	m	
	groupDirectory				m	
		directoryDetails			m	
			firstName	Text	o	Max. 24 characters. except "&'<>
			lastName	Text	o	Max. 24 characters. except "&'<>
			number	0~9, #, *	o	1~32 digits
		extension	0~9, #, *	o	1~32 digits	

[Syntax]

```
<?xml version="1.0" encoding="ISO-8859-1"?>
<Group>
  <startIndex>1</startIndex>
  <numberOfRecords>2</numberOfRecords>
  <totalAvailableRecords>2</totalAvailableRecords>
  <groupDirectory>
    <directoryDetails>
      <firstName>David</firstName>
      <lastName>Allan</lastName>
      <number>1111001</number>
      <extension>1001</extension>
    </directoryDetails>
    <directoryDetails>
      <firstName>George</firstName>
      <lastName>Williams</lastName>
      <number>1111010</number>
      <extension>1010</extension>
    </directoryDetails>
  </groupDirectory>
</Group>
```

[LCD Image]

[c.f. 4.3.2.2. Network Phonebook Operations](#)

6. Appendix

6.1. Error Code Reference

The following is error code list which is displayed in the LCD of the phone.

Error Code (In Hex)	Error Description
Common	
0001	Normally Completed
Parser Error	
0101	Can not Receive Bitmap (Size Over)
0102	Wrong File (File type is not XML nor BMP)
0103	Can not handle elements (Too much Elements)
0104	Missing of '>' or '<'.
0105	Memory Allocation Error
0106	Cannot access to Network
01A0	File receiving error : cancel
01A1	File receiving error : Wrong Parameter
01A2	File receiving error : Illegal URL syntax
01A3	File receiving error : Connection error
01A4	File receiving error : Could not resolve the name
01A5	File receiving error : No response from Server
01A6	File receiving error : Receiving wrong message
01A7	File receiving error : Server response with error
01A8	File receiving error : File Not Found
01A9	File receiving error: Authentication failed.
01AA	File receiving error : SSL communication error
01AB	File receiving error : SSL certification error
01AC	File receiving error : Redirect with wrong protocol
01AD	File receiving error : File already exist without overwriting
01AE	File receiving error : system error
01AF	File receiving error : Socket Error
01B0	File receiving error : File error
01B1	File receiving error : Memory Error
01B2	File receiving error : Busy from Server
01BF	File receiving error : other error
01F0	Unexpected space is added (Software error)
01F1	Wrong in string (Software error)
ppxml	
None	
Screen	
0301	Unsupported XML
SetVariable	
0401	No elements
0402	Unsupported Key
Components	
None	
Timer	
0801	Wrong attribute
0802	Failed to allocate timer
Label	

0901	No Label Element
0902	Wrong name Attribute
0903	Wrong line Attribute
0904	Wrong area Attribute
0905	Wrong text Attribute
0906	Wrong textAlignment Attribute
0907	Wrong showDateTime Attribute
0908	Wrong refreshDateTime Attribute
PictureBox	
0A01	No PictureBox Element
0A02	Wrong left Attribute
0A03	Wrong top Attribute
0A04	Wrong width Attribute
0A05	Wrong height Attribute
0A06	Wrong source Attribute
0A07	Failed in URL sending request
TextBox	
0B01	No TextBox Element
0B02	Failed to initialize TextBox
0B03	Wrong name Attribute
0B04	Wrong line Attribute
0B05	Wrong area Attribute
0B06	Wrong text Attribute
0B07	Wrong textAlignment Attribute
0B08	Wrong password Attribute
0B09	Wrong maxLength Attribute
Events	
0C01	Wrong Element (SoftKey)
0C02	Wrong Element (FFKey)
0C03	Wrong Element (Timer)
0C04	Wrong Element (OnTalking)
0C05	Wrong Element (OnHungup)
0C06	Wrong Element (MenuItems)
0C07	Wrong Element (MenuItem)
0C08	Wrong Element (PageKey)
0C09	Wrong Element(OnClicked)
0C0A	Wrong Element(OnExpired)
0C0B	Wrong Element(Events)
0C0C	Wrong Element(SendRequest)
0C0D	Wrong Element(MakeCall)
0C0E	Wrong Element(AnswerCall)
0C0F	Wrong Element(HangupCall)
0C11	Wrong Element(SetXmlMode)
0C12	Wrong Element(Reboot)
0C20	Illegal Call of OnClicked (Call not by SoftKey/FFKey/MenuItem/PageKey)
0C21	Illegal Call of OnExpired (Call not by Timer)
0C22	Illegal Call of OnTalking (Call not by beginning of conversation)
0C23	Illegal Call of OnHungup (Call not by end of conversation)
0C30	SendRequest NG

0C40	MakeCall NG
0C50	AnswerCall NG
0C60	HangupCall NG
0C80	SetXmlMode NG
0C90	Reboot NG
<u>Trigger</u>	
0D01	Wrong Element (Trigger)
0D02	Wrong Element (Source)
0D10	SendRequest NG
<u>Execute</u>	
0E01	Wrong Element (Execute)
0E20	SetXmlMode NG
0E30	Reboot NG
<u>Menu</u>	
0F01	Wrong Element (Element Name)
0F02	Wrong Element (Attribute area)
0F10	Operation error with menu navigation (Illegal operation with Navigation)
0F11	Operation error with menu navigation (Illegal Key)
0F12	Operation error with menu navigation (Failed to get id)
0F13	Operation error with menu navigation (Failed to get Text)
0F14	Operation error with menu navigation (Failed to get textAlignment)
0F15	Operation error with menu navigation (Un supported LCD)
0F16	Operation error with menu navigation (No MenuItem Element)
0F20	Operation error with menu navigation (No menu selection)
0FFF	No element
<u>SoftKeys</u>	
1001	Wrong Element (Element Name)
1002	Wrong Element (Attribute id)
1003	Wrong Element (Attribute text)
1010	Soft Key Display process error
1020	Soft Key Display Character Error
1021	Soft Key Display Area Error
1030	Soft Key Clear Error
1040	Soft Key Event Error (Wrong Key)
10FF	No element
<u>FFKeys</u>	
1101	Wrong Element (Element Name)
1102	Wrong Element (Attribute id)
1103	Wrong Element (Attribute text)
1110	DesiLess Display Area Error (Illegal id)
1111	DesiLess Display Area Error (Illegal text)
1112	DesiLess Display Area Error (Un Supported LCD)
1120	FF Key Event Error (Illegal Key)
11FF	No element
<u>PhoneBook</u>	
None	
<u>Menuitems</u>	
1401	Wrong Element (Element Name)
1402	Wrong Element (Attribute id)

1403	Wrong Element (Attribute text)
1404	Wrong Element (selected Attribute)
1410	Phone Display Area Error (Un Supported LCD)
1420	Phone Display Area Error (Illegal id)
1421	Phone Display Area Error (Illegal textAlignment)
1422	Phone Display Area Error (Illegal selected)
1423	Phone Display Area Error (Illegal text)
1424	Phone Display Area Error (Error in saving selected id)
1430	Wrong area of display menu.
14FF	No Element
PageKeys	
1501	Wrong Element (Element Name)
1502	Wrong Element (Attribute id)
1510	Unsupported LCD
1520	Page Key Event Error (Illegal Key)
15FF	No Element

6.2. Editing XML contents on the PC

The PC free software, called 'XML Notepad 2007' made by Microsoft®, can check schema error on PC. It is useful for basic editing and checking contents before actually loading to the phone.

Tool name: **XML Notepad 2007** (Please obtain it from the Microsoft® website).

All schema files of the phone must be copied onto the same folder as the XML contents folder beforehand to avoid schema errors.

For more detail, please confirm the help of this tool.

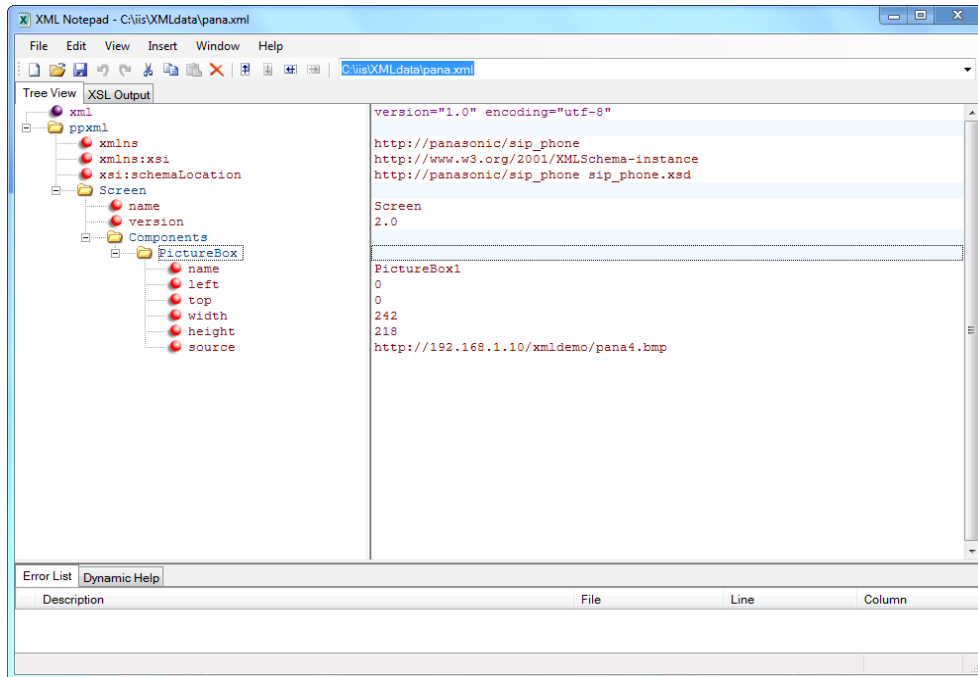

Screen Image

<End of doc>